

# JVC



ENGLISH  
DEUTSCH  
FRANÇAIS  
NEDERLANDS  
CASTELLANO  
ITALIANO  
PORTUGUÊS

**D.I.S.T.**

Digital Image Scaling Technology

InteriArt

**LT-32C50BU**

**LT-26C50BU**

**LT-32C50SU**

**LT-26C50SU**

**T-V LINK**

**WIDE LCD PANEL TV**

**INSTRUCTIONS**

**16:9 LCD TV**

**BEDIENUNGSANLEITUNG**

**TELEVISEUR A ECRAN LCD PANORAMIQUE**

**MANUEL D'INSTRUCTIONS**

**BREEDBEELD LCD TV**

**GEBRUIKSAANWIJZING**

**TELEVISOR CON PANEL LCD PANORÁMICO**

**MANUAL DE INSTRUCCIONES**

**TV LCD WIDESCREEN**

**ISTRUZIONI**

**TELEVISOR COM ECRÃ PANORÂMICO DE  
CRISTAL LÍQUIDO**

**INSTRUÇÕES**



Thank you for buying this JVC LCD flat television.  
To make sure you understand how to use your new TV, please read this manual thoroughly before you begin. ("LCD" stands for Liquid Crystal Display.)

**WARNING: TO PREVENT FIRE OR SHOCK HAZARD, DO NOT EXPOSE THIS APPLIANCE TO RAIN OR MOISTURE.**

### WARNING

- Fingers may be trapped under the TV causing injuries. Hold the TV at the bottom in the middle, and do not allow it to tilt up or down.



### WARNING

- The TV may fall causing injuries. Hold the bottom of the stand with your hand and tilt the TV up and down.
- Do not allow children to hang from the TV, place their elbows on the TV or lean against the TV. Doing so may cause the TV to fall over and lead to injuries.

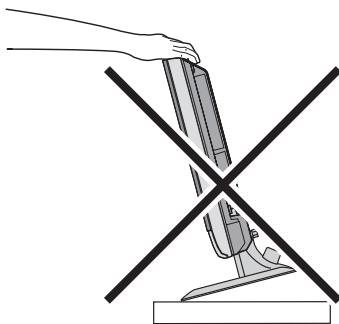

### CAUTION

- The TV screen may be damaged if the TV is carried as shown in the diagram below. The TV should always be carried by two people.

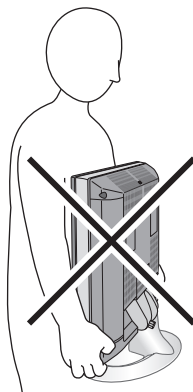

## Pixel defects

LCDs use collections of fine points (“pixels”) to display images. While there is no problem with more than 99.99% of these pixels, please understand that a very small number of pixels may not light, or may light all the time.

## Distance recommendations

Avoid improper installation and never position the unit where good ventilation is impossible.

When installing this TV, distance recommendations must be maintained between the set and the wall, as well as inside a tightly enclosed area or piece of furniture. Keep to the minimum distance guidelines shown for safe operation.

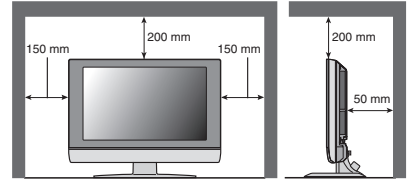

## Failure to take the following precautions may cause damage to the television or remote control.

### DO NOT block the TV’s ventilation openings or holes.

(If the ventilation openings or holes are blocked by a newspaper or cloth, etc., the heat may not be able to get out.)

### DO NOT place anything on top of the TV.

(such as cosmetics or medicines, flower vases, potted plants, cups, etc.)

### DO NOT allow objects or liquid into the cabinet openings.

(If water or liquid is allowed to enter this equipment, fire or electric shock may be caused.)

### DO NOT place any naked flame sources, such as lighted candles, on the TV.

### DO NOT subject the TV to direct sunlight.

The surface of the TV screen is easily damaged. Be very careful with it when handling the TV. Should the TV screen become soiled, wipe it with a soft dry cloth. Never rub it forcefully. Never use any cleaner or detergent on it.

If there is a fault, unplug the unit and call a service technician. Do not attempt to repair it yourself or remove the rear cover.

## ■ Cleaning the screen

The screen is coated with a special thin film to reduce reflection. If this film is damaged, uneven colors, discoloration, scratches, and other problems that cannot be repaired may occur. Pay attention to the following when handling the screen.

- Do not use glue or adhesive tape on the screen.
- Do not write on the screen.
- Do not allow the screen to come in contact with any hard objects.
- Do not allow condensation to form on the screen.
- Do not use alcohol, thinner, benzene or other solvents on the screen.
- Do not rub the screen hard.

---

### CAUTION:

- Operate only from the power source specified (AC 110 – 240 V, 50/60 Hz) on the unit.
  - Avoid damaging the AC plug and power cord.
  - When you are not using this unit for a long period of time, it is recommended that you disconnect the power cord from the main outlet.
- 

### D.I.S.T. demonstration

To start the D.I.S.T. demonstration:

Press the **MENU** button to display the menu bar. Then press the yellow button.

A picture split in two (D.I.S.T. turned on and D.I.S.T. turned off) will appear on the screen.

To quit the D.I.S.T. demonstration:

Press the yellow button, **TV** button, **P**  $\vee/\wedge$  buttons or any of the number buttons.

---

# CONTENTS

---

|  |           |  |           |
|--|-----------|--|-----------|
| <b>Setting up your TV</b> .....                                  | <b>5</b>  | <b>PICTURE menu</b> .....                        | <b>29</b> |
| Installation .....   | 5         | PICTURE MODE .....                               | 29        |
| Using the stand .....  | 5         | BRIGHT-1 .....                                   | 29        |
| Removing the terminal covers .....                               | 6         | CONTRAST .....                                   | 29        |
| Connecting the aerial and video cassette recorder (VCR) .....    | 7         | BRIGHT-2 .....                                   | 29        |
| Connecting the power cord to the AC outlet .....                 | 8         | SHARP .....                                      | 29        |
| Putting the batteries into the remote control .....              | 8         | COLOUR .....                                     | 29        |
| Initial settings .....   | 8         | HUE .....  | 29        |
| T-V LINK functions .....   | 11        | COLOUR TEMP .....                                | 29        |
| <b>TV buttons and functions</b> .....                            | <b>13</b> | FEATURES .....                                   | 30        |
| Turn the TV on from standby mode .....                           | 13        | <b>SOUND menu</b> .....                          | <b>33</b> |
| Choose a TV channel .....  | 13        | STEREO / I • II .....                            | 33        |
| Watch images from external devices .....                         | 13        | BASS .....                                       | 33        |
| Adjust the volume .....  | 14        | TREBLE .....                                     | 33        |
| Using the Menu .....   | 14        | BALANCE .....                                    | 33        |
| <b>Remote control buttons and functions</b> .....                | <b>15</b> | 3D SOUND .....                                   | 33        |
| Turn the TV on or off from standby mode ...                      | 15        | A.H.B. (Active Hyper Bass) .....                 | 33        |
| Choose a TV channel and watch images from external devices ..... | 16        | BBE .....  | 33        |
| Adjust the volume .....  | 17        | <b>FEATURES menu</b> .....                       | <b>34</b> |
| Information function .....                                       | 17        | SLEEP TIMER .....                                | 34        |
| ZOOM function .....  | 18        | CHILD LOCK .....                                 | 34        |
| 3D SOUND function .....  | 19        | APPEARANCE .....                                 | 35        |
| Return to TV channel instantly .....                             | 19        | BLUE BACK .....                                  | 35        |
| Using the "Freeze" function .....                                | 20        | FAVOURITE SETTING .....                          | 36        |
| Using the "Multi-picture" function .....                         | 20        | <b>SET UP menu</b> .....                         | <b>37</b> |
| Favourite channel function .....                                 | 22        | AUTO PROGRAM .....                               | 37        |
| Operating a JVC brand VCR or DVD player .....                    | 23        | EDIT/MANUAL .....                                | 37        |
| <b>Teletext function</b> .....                                   | <b>24</b> | LANGUAGE .....                                   | 41        |
| Basic operation .....  | 24        | DECODER (EXT-2) .....                            | 41        |
| Using the List Mode .....  | 24        | COMPONENT AUTO SELECT .....                      | 42        |
| Hold .....   | 25        | EXT SETTING .....                                | 42        |
| Sub-page .....   | 25        | <b>Displaying a computer screen</b> .....        | <b>45</b> |
| Reveal .....   | 25        | Connecting to the computer .....                 | 45        |
| Size .....   | 25        | Watching images from a computer .....            | 45        |
| Index .....  | 26        | Table of signals for each type of computer ..... | 45        |
| Cancel .....   | 26        | <b>Additional preparation</b> .....              | <b>46</b> |
| <b>Using the TV's menu</b> .....                                 | <b>27</b> | Connecting external equipment .....              | 46        |
| Basic operation .....  | 27        | <b>CH/CC numbers</b> .....                       | <b>50</b> |
|  |           | <b>Troubleshooting</b> .....                     | <b>52</b> |
|  |           | <b>Specifications</b> .....                      | <b>55</b> |

# Setting up your TV

- When you install the TV on the wall, only use a JVC wall mounting unit (optional) which is designed for this TV.
- Make sure that the TV is installed on the wall by a skilled installer.

## Installation

### Cautions for installation

- Install the TV in a corner on a wall or on the floor so as to keep cords out of the way.
- The TV will generate a slight amount of heat during operation. Ensure that sufficient space is available around the TV to allow satisfactory cooling. See “Distance recommendations” on page 2.

## Using the stand

### This TV comes with a table top stand already attached.

This stand can be used to adjust the direction of the TV screen 5° up, 10° down, and 20° to the left or right.

#### ■ Tilt the TV up and down:

While holding the bottom of the stand with one hand, use your other hand to hold the middle of the top of the TV and slowly tilt the TV up and down.

- As a safety measure, the stand needs a certain amount of force to tilt the TV.

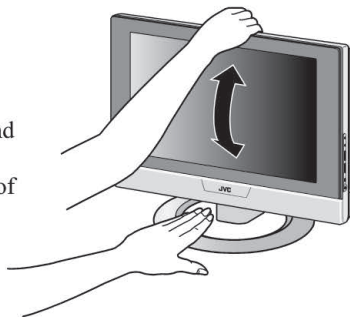

#### ■ Rotate the TV to the left and right:

While holding the bottom of the stand with one hand, use your other hand to hold the edge of the panel and slowly adjust the direction of the TV screen.

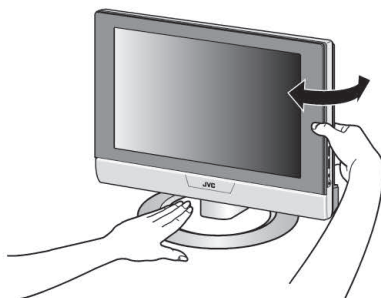

■ **Cable holder**

A cable holder which is used to keep the connection cables tidy is attached to the back of the stand. Gently squeeze the left and right of the cable holder and pull it to remove it from the stand. After putting the cables in the cable holder, attach it to the back of the stand again.

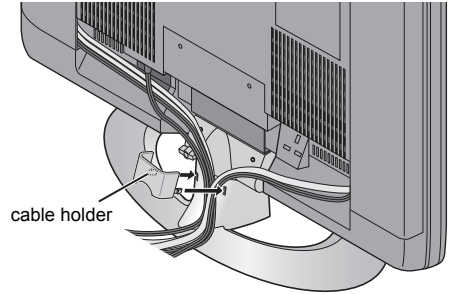

---

**Removing the terminal covers**

---

There are connection terminals behind the covers on the left and right of the rear of the TV. Remove these two covers before connecting an antenna or VCR.

Remove the covers by removing the hooks. When replacing the covers, place the side of the covers against the TV and insert the hooks.

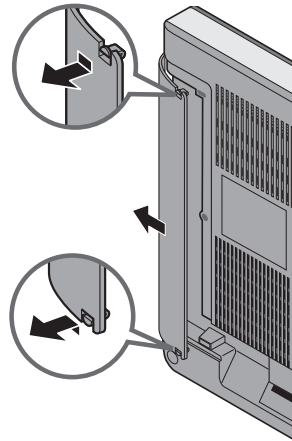

- 
- Leave the covers off if they do not fit properly. Do not force to replace the covers. Doing so may cause damage to the connection cables and the covers.
-

## Connecting the aerial and video cassette recorder (VCR)

- The connecting cables are not provided.
- For further details, refer to the manuals provided with the devices to be connected.

### Caution

- Turn off all the equipment including the TV before connecting anything.

■ If you are connecting a VCR, follow (A) → (B) → (C) in the diagram opposite.

■ If you are not connecting a VCR, follow ①.

To use the T-V LINK functions, you must have a T-V LINK compatible VCR connected by a SCART cable (C) to the EXT-2 terminal on the TV. For details about T-V LINK functions, see “T-V LINK functions” on page 11.

- You can watch a video using the VCR without doing (C). For details, see your VCR instruction manual.
- To connect more equipment, please see “Connecting external equipment” on page 46.
- To connect additional audio equipment, see “Connecting speakers/amplifier” on page 49.
- If you connect a decoder to a T-V LINK compatible VCR, set the DECODER (EXT-2) function to ON. For details, see “DECODER (EXT-2)” on page 41. Otherwise, you will not be able to watch scrambled channels.

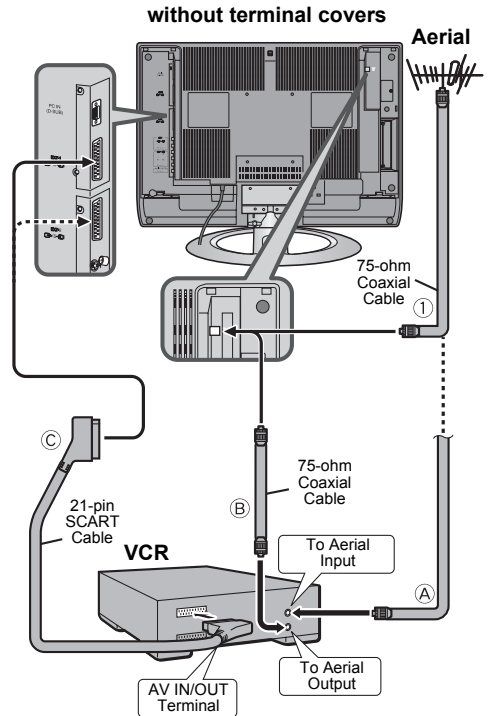



## Connecting the power cord to the AC outlet

Insert the AC plug on the power cord from the TV into an AC outlet.

### Caution

- Operate only from the power source specified (AC 110 – 240 V, 50/60 Hz) on the unit.
- Remove the AC plug from the outlet to completely disconnect the TV from the power supply.

## Putting the batteries into the remote control

Use two AA/R6 dry cell batteries. Insert the batteries from the ⊖ end, making sure the ⊕ and ⊖ polarities are correct.

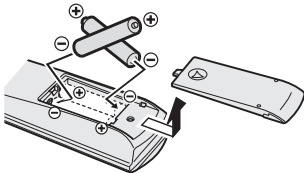

- Follow the warnings printed on the batteries.
- Battery life is about six months to one year, depending on how much you use the remote control.
- The batteries we supply are only for setting up and testing your TV, please replace them as soon as you need to.
- If the remote control does not work properly, replace the batteries.

## Initial settings

When the TV is first turned on, it goes into the initial settings mode, and you will see the JVC logo. Follow the instructions on the screen display to make the initial settings.

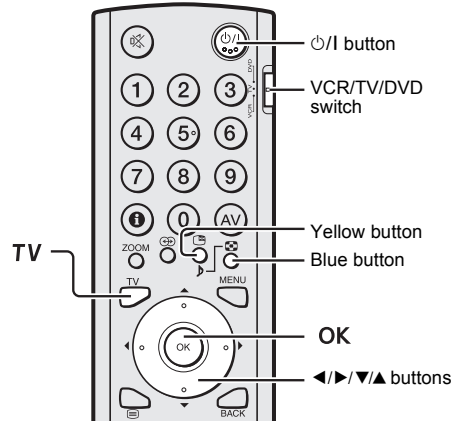

### 1 Make sure to set the VCR/TV/DVD switch on the remote control to the TV position

- You cannot turn the TV on when the VCR/TV/DVD switch is set to the VCR or DVD position.

### 2 Press the ⏻ button on the remote control

The TV turns on from standby mode and the JVC logo is displayed.

- Check that the AC plug on the power cord from the TV is connected to AC outlet.

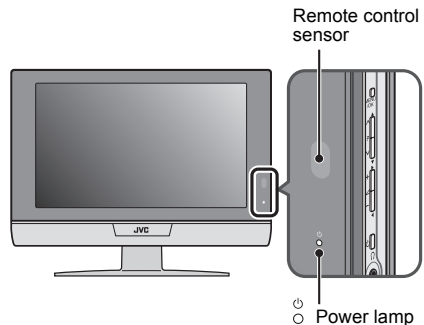

- If the JVC logo does not appear this is because your TV has already been turned on for the first time: use the “LANGUAGE” and “AUTO PROGRAM” functions to make the initial settings. For details, see “SET UP menu” on page 37.

### 3 Press the OK button

The LANGUAGE menu appears.

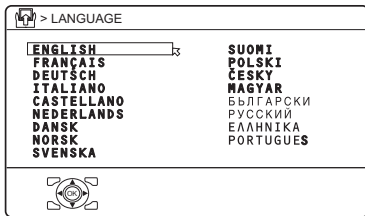

D0002(E)-EN

### 4 Press the ▼/▲ buttons to choose ENGLISH. Then press the OK button

The on-screen display will then be in English. The COUNTRY menu appears as a sub-menu of the AUTO PROGRAM function. There are two COUNTRY menus. Pressing the yellow button changes the COUNTRY menu as follows:

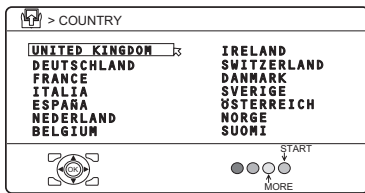

D0003-EN

### 5 Press the ◀/▶ and ▼/▲ buttons to choose the country where you are

### 6 Press the blue button to start the AUTO PROGRAM function

The AUTO PROGRAM menu appears and received TV channels are automatically stored in the programme numbers (PR).

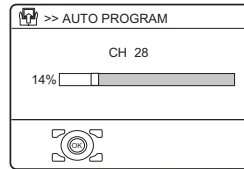

D0004-EN

- Perform the “ACI function” operation (see page 10) when “ACI START/ACI SKIP” is displayed.
- To cancel the AUTO PROGRAM function: Press the TV button.



**After the TV channels have been registered in the programme numbers (PR), the EDIT menu appears**

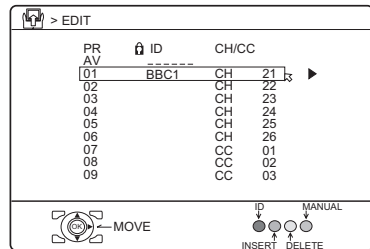

D0008-EN

- If you want to, you can now edit the programme numbers (PR) using the EDIT/MANUAL function. For details, see “EDIT/MANUAL” on page 37.
- If you do not want to edit programme numbers (PR), go to the next step.

## 7 Press the **OK** button to display the T-V LINK menu

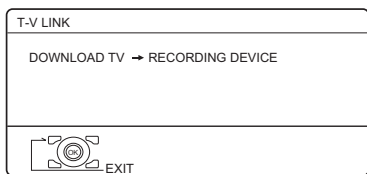

### If you do not have a T-V LINK compatible VCR connected:

Press the **TV** button to exit the T-V LINK menu.

The T-V LINK menu disappears.

### If you have a T-V LINK compatible VCR connected to the EXT-2 terminal:

Follow the operating procedure “Downloading the data to VCR” on page 11 to transmit the Programme number (PR) data.

## Now, the initial settings are complete, and you can watch the TV

- If your TV can detect the TV channel name from the TV channel broadcast signal, the TV channel name is assigned to the programme number (PR) to which the TV channel has been set. However, which TV channels are set to which programme numbers (PR) will depend on the area in which you live.
- If a TV channel you want to view is not set to a programme number (PR), you can set it using the MANUAL function. For details, see “EDIT/MANUAL” on page 37.
- The AUTO PROGRAM function does not set the programme number PR 0 (AV) for your video cassette recorder. You will need to set this using the MANUAL function.

## ■ ACI function

This TV has an ACI function which decodes the ACI (Automatic Channel Installation) data.

Using the ACI function allows all TV channels transmitted from the cable TV station to be properly registered quickly according to the data from the cable TV station.

### If “ACI START/ACI SKIP” appears in the AUTO PROGRAM menu:

You can use the ACI (Automatic Channel Installation) function to decode the ACI data and complete the registration of all the TV channels in a short period of time.

### Press the **▼/▲** buttons to choose ACI START. Then press the **OK** button to start the ACI function

Depending on your cable TV station, there may be a broadcast selection menu set up by the cable TV station.

Follow the menu instructions and use the **◀/▶** and **▼/▲** buttons to operate the menu. After you have made the setting, press the **OK** button.

- If you have any questions about the items in the Broadcast Selection menu or how to operate the menu, please contact your cable TV station.
- If you do not want to use the ACI function, press the **▼/▲** buttons to choose ACI SKIP and then press **OK**.
- When the cable TV broadcast reception is poor, the ACI function will not work properly.
- If there is an error in the ACI data itself, the TV channel cannot be registered properly. If this happens, turn the ACI function off (ACI SKIP) and use the AUTO PROGRAM function. Alternatively, use the EDIT/MANUAL function to correct the Programme number (PR) setting.

### If “ACI ERROR” is displayed in the AUTO PROGRAM menu:

“ACI ERROR” means that the ACI function is not working properly. Press the ◀ button to start the ACI function again.

If “ACI ERROR” still appears even after you have tried to start the ACI function several times, press the ▶ button to start the AUTO PROGRAM function. It does not cause any problem because all the TV channels are registered to the Programme numbers (PR) by the AUTO PROGRAM function.

### ■ Downloading the data to VCR

You can transmit the latest Programme numbers (PR) data to a VCR with the T-V LINK function.

#### Caution

- This only works when a T-V LINK compatible VCR is connected to the EXT-2 terminal.
- This only works when the T-V LINK menu is being displayed.

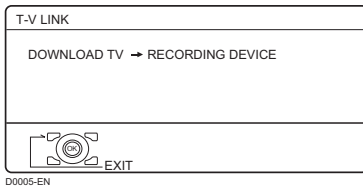

### 1 Turn on the VCR

### 2 Press the OK button

The data transmission begins.

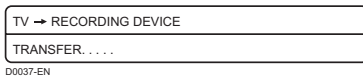

The T-V LINK menu disappears once the data transmission ends.

### When the T-V LINK menu is changed over to another menu:

The TV has finished its menu. This new menu is operated from the VCR. See the VCR instruction manual for what to do next.

### If “FEATURE NOT AVAILABLE” appears at the T-V LINK menu:

Check the following three items. Then press the ◀ button to retry data transmission.

- Has a T-V LINK compatible VCR been connected to the EXT-2 terminal?
- Has the VCR power been turned on?
- Does the SCART cable that is connected to the EXT-2 terminal to T-V LINK compatible VCR have all its proper connections?

## T-V LINK functions

When you have a T-V LINK compatible VCR connected to the EXT-2 Terminal on the TV, it is easier to set up the VCR and to view videos. T-V LINK uses the following features:

#### To use T-V LINK functions:

A “T-V LINK compatible VCR” means a JVC video cassette recorder with the T-V LINK logo, or with one of the following logos. However, these VCRs may support some or all of the features described earlier. For details, see your VCR instruction manual.

“Q-LINK” (a trademark of Panasonic Corporation)

“Data Logic” (a trademark of Metz Corporation)

“Easy Link” (a trademark of Phillips Corporation)

“Megalogic” (a trademark of Grundig Corporation)

“SMARTLINK” (a trademark of Sony Corporation).

### ■ Pre-set download

The VCR will automatically download the registered data on the TV channels from the TV. This means you do not need to set up the program channels on your VCR manually. The preset download function automatically begins when the initial setting is complete or whenever you carry out the AUTO PROGRAM or EDIT/MANUAL functions. You can also carry out this function using your VCR controls.

#### **When “FEATURE NOT AVAILABLE” is displayed:**

If “FEATURE NOT AVAILABLE” is displayed, the download was not performed correctly. Before trying to download again, check that:

- the VCR power is turned on
- the VCR is T-V LINK compatible
- the VCR is connected to the EXT-2 terminal
- the SCART cable is fully wired.

### ■ Direct Rec

“What You See Is What You Record”

You can easily record to VCR the images that you are watching on the TV.

For details, read the manual for your VCR. Use your VCR controls. “DEVICE IS RECORDING” is displayed.

**In the following situations, the VCR will stop recording if the TV is turned off, if the TV channel or input is changed, or if the menu is displayed on the TV:**

- when recording images from an external device connected to the TV (for example a camcorder)
- when recording a TV channel after it has been unscrambled on a decoder
- when recording a TV channel by using the TV’s output because the VCR’s own tuner cannot properly receive that channel.

You cannot carry out Direct Rec using your TV’s control.

Generally, the VCR cannot record a TV channel that it cannot receive properly on its own tuner, even if you can view that TV channel on the TV. However, some VCRs can record a TV channel by using the TV’s output if that channel can be viewed on the TV. For details, see your VCR instruction manual.

When the VCR is not ready, the following messages are displayed.

| <b>ERROR MESSAGE</b>        | <b>Cause and countermeasure</b>  |
|-----------------------------|--|
| NO RECORDING                | The VCR is not able to record.<br>Check the VCR.   |
| NO RECORDING POSSIBLE       | The TV input is set to EXT-4 or PC. Since the EXT-4 picture or PC picture cannot be output to EXT-2, DIRECT REC is not possible. |
| NO RECORDING, MEDIA PROBLEM | The recording device is not ready to record. Check the VCR tape.   |
| NO RECORDING, DEVICE BUSY   | The recording device cannot record as it is recording or playing. Check the VCR.   |

Refer to the VCR instruction manual.

# TV buttons and functions

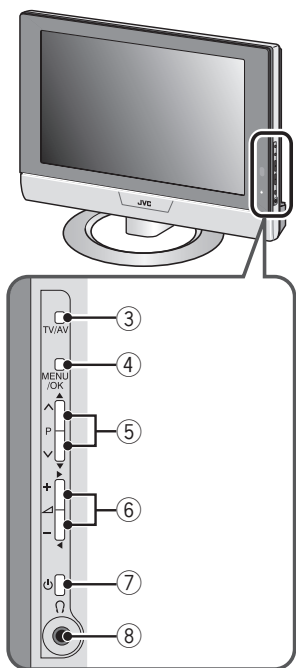
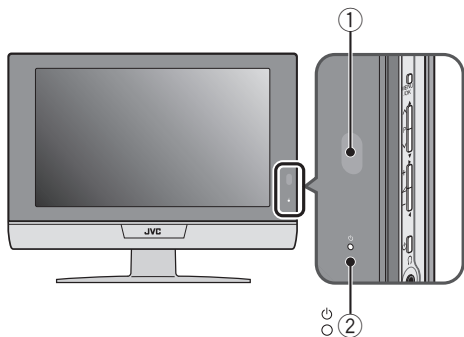

Refer to the pages in parentheses for details.

- ① Remote control sensor
- ② Power lamp (page 8)
- ③ TV/AV button (page 13)
- ④ MENU/OK button (pages 14, 28)
- ⑤ P  $\nabla/\wedge$  buttons (page 13)
- ⑥  $\nabla$  (Volume)  $-/+$  buttons (page 14)
- ⑦  $\odot$  (Stand by) button (page 13)
- ⑧ Headphone jack (mini jack) (page 46)

## Turn the TV on from standby mode

Press the  $\odot$  button or the P  $\nabla/\wedge$  buttons to turn the TV on from standby mode.

When the TV is turned on, the power lamp lights blue.

**To turn the TV off:**

Press the  $\odot$  button again.  
The power lamp goes off.

## Caution

- The  $\odot$  button on the TV does not fully isolate the TV from the AC supply. If you are not going to use the TV for a long period, be sure to disconnect the AC plug from the AC socket.

## Choose a TV channel

Press the P  $\nabla/\wedge$  buttons to choose a programme number (PR) or an EXT terminal

## Watch images from external devices

Press the TV/AV button to choose an EXT terminal

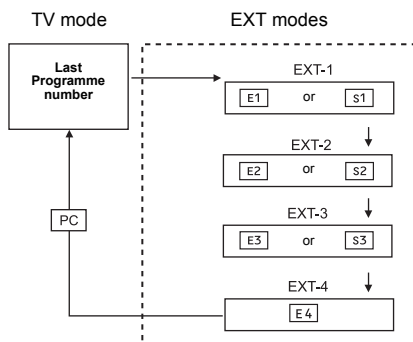

---

## Adjust the volume

---

**Press the  (Volume) -/+ buttons**

The volume level indicator appears.

---

## Using the Menu

---

**Use the MENU/OK button**

Refer to “Using the TV’s menu” (see page 27) for details of using the menu.

# Remote control buttons and functions

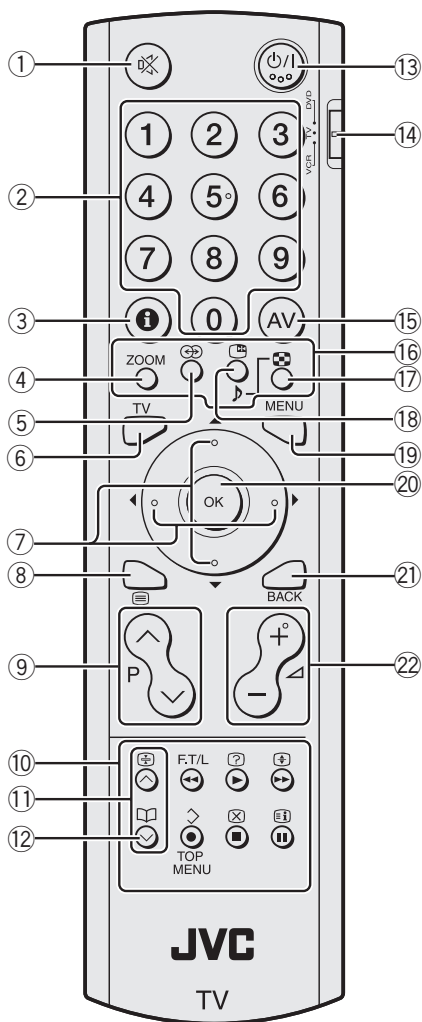

- ① Muting button
- ② Number buttons
- ③ Information button
- ④ **ZOOM** button
- ⑤ **TV** button
- ⑥ **TV** button
- ⑦ ◀/▶/▼/▲ buttons
- ⑧ (Text) button
- ⑨ **P** V/∧ buttons
- ⑩ VCR/DVD/Teletext control buttons
- ⑪ V/∧ buttons
- ⑫ (Favourite) button
- ⑬ ⏻/⏼ (Standby) button
- ⑭ VCR/TV/DVD switch
- ⑮ **AV** button
- ⑯ Colour buttons
- ⑰ (Multi) button
- ⑱ (Freeze/Select) button
- ⑲ **MENU** button
- ⑳ **OK** button
- ㉑ **BACK** button
- ㉒ ◀ (Volume) -/+ buttons

## Turn the TV on or off from standby mode

**Press the ⏻/⏼ (standby) button to turn the TV on or off**

When the TV is turned on, the power lamp lights blue.

- The power can be turned on by pressing the **TV** button, **P** V/∧ buttons or Number buttons.

To turn the TV on or off, set the VCR/TV/DVD switch on the remote control to the TV position and press the ⏻/⏼ button. If the VCR/TV/DVD switch on the remote control is set to a position other than TV, the TV will not be turned on or off even if the ⏻/⏼ button is pressed.



## Choose a TV channel and watch images from external devices

### ■ Use the number buttons: Enter the programme number (PR) of the channel using the number buttons.

Example:

- PR 6 → press **6**
- PR 12 → press **1** and **2**

### ■ Use the **P** $\nabla/\blacktriangle$ buttons: Press the **P** $\nabla/\blacktriangle$ buttons to choose the programme number (PR) you want or an EXT terminal.

### ■ Use the **AV** button: Press the **AV** button to choose an EXT terminal.

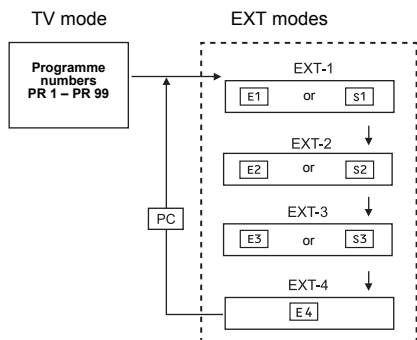

- You can choose a video input signal from the S-VIDEO signal (Y/C signal) and regular video signal (composite signal). For details, see “S-IN (S-VIDEO input)” on page 42.
- If you do not have a clear picture or no colour appears, change the colour system manually. See “COLOUR SYSTEM” on page 32.
- If you choose an EXT terminal with no input signal, the EXT terminal number becomes fixed on the screen.

- This TV set has a function which can automatically change over the input according to a special signal output from an external device. (The EXT-3 terminal does not support this function.)
  - When EXT-4 is chosen, motion differs according to the “COMPONENT AUTO SELECT” setting in the SET UP menu. For details, see “COMPONENT AUTO SELECT” on page 42.
- Since this TV is designed to make full use of the resolution of the original video source, the motion may appear unnatural when the video source is input with progressive-scanning component signals. If this happens, change the output setting of the connected device to interlace-scanning component signal output. See the instructions that came with the device for more information.
- The PC sound is the same as the EXT-3 sound.

### To return to a TV channel:

Press the **TV** button, the  $\nabla/\blacktriangle$  buttons or the number buttons.

### To use the programme number PR 0 (AV):

When the TV and VCR are connected only by the aerial cable, choosing the programme number PR 0 (AV) allows you to view images from the VCR. Set the VCR RF channel to the programme number PR 0 (AV) manually. For details, see “EDIT/MANUAL” on page 37.

Pressing the **AV** button changes the choice as follows:

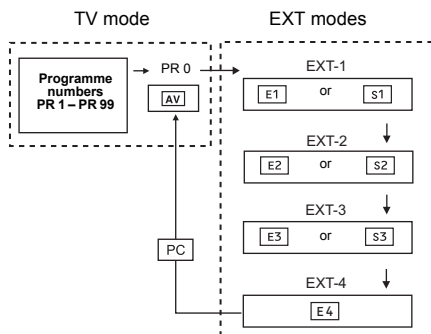

- The VCR sends its playback image along the aerial cable as an RF (radio frequency) signal.
- Also see your VCR instruction manual.

## Adjust the volume

Press the buttons to adjust the volume.

The volume level indicator appears and the volume changes as you press the buttons.

### ■ Muting the sound

Press the (muting) button to turn off the sound.

Pressing the (muting) button again restores the previous volume level.

## Information function

You can see the channel number of the programme you are watching, the current time or the PR LIST.

From the PR LIST, you can choose a channel or EXT terminal.

Press the (Information) button to display the information you want to see.

Pressing the (Information) button changes the display as follows:

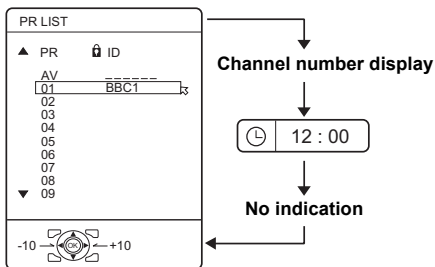

### Channel number display:

The channel number and channel name (when the channel name is registered) of the programme you are watching or the EXT terminal number is displayed.

### Time display:

The current time of the teletext data is displayed.

If the TV has not received a TV channel that has teletext programmes since it was turned on, the time display is blank. To view the current time, choose a TV channel that has teletext programmes.

- An incorrect current time is sometimes displayed when watching videos.

### PR LIST:

The programme number (PR) and EXT terminal list is displayed.

Pressing the **OK** button after choosing the programme number (PR) or EXT terminal with the buttons will display the chosen programme or EXT terminal.

- For programme numbers (PR) for which the CHILD LOCK function is set, the (CHILD LOCK) mark is displayed. For details see “CHILD LOCK” on page 34.
- For programme numbers (PR) which is registered as a favourite channel, the (favourite) mark is displayed. For details see “Favourite channel function” on page 22.

## ZOOM function

You can change the screen size according to the picture aspect ratio. Choose the optimum one from the following ZOOM modes.

- The ZOOM mode is fixed at FULL when you are using the TV as a PC screen.

### AUTO:

When a WSS (Wide Screen Signalling) signal, which shows the aspect ratio of the picture, is included in the broadcast signal or the signal from an external device, the TV automatically changes the ZOOM mode to 16:9 ZOOM mode or FULL mode according to the WSS signal.

If a WSS signal is not included, the picture is displayed according to the ZOOM mode set with the 4:3 AUTO ASPECT function.

- For details of the 4:3 AUTO ASPECT function, see “4:3 AUTO ASPECT” on page 32.
- When the AUTO (WSS) mode does not function correctly due to poor WSS signal quality or when you want to change the ZOOM mode, press the **ZOOM** button and change to another ZOOM mode.

### REGULAR:

Use to view a normal picture (4:3 aspect ratio) as this is its original shape.



### PANORAMIC:

This stretches the left and right sides of a normal picture (4:3 aspect ratio) to fill the screen, without making the picture appear unnatural.

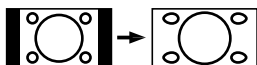

- The top and bottom of the picture are slightly cut off.

### 14:9 ZOOM:

This zooms up the wide picture (14:9 aspect ratio) to the upper and lower limits of the screen.

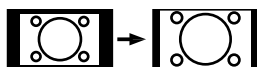

### 16:9 ZOOM:

This zooms up the wide picture (16:9 aspect ratio) to the full screen.

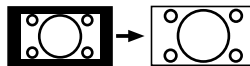

### 16:9 ZOOM SUBTITLE:

This zooms up the wide picture (16:9 aspect ratio) with subtitles to the full screen.

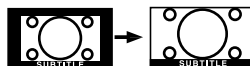

### FULL:

This uniformly stretches the left and right sides of a normal picture (4:3 aspect ratio) to fill the wide TV screen.



- For 16:9 aspect ratio pictures that have been squeezed into a normal picture (4:3 aspect ratio), use the FULL mode to restore the picture to its original shape.

## ■ Choose the ZOOM mode

### 1 Press the **ZOOM** button to display the ZOOM menu

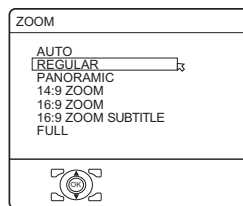

00009-EN

### 2 Press the **▼/▲** buttons to choose a ZOOM mode. Then press the **OK** button

The picture expands and the chosen ZOOM mode is displayed in about 5 seconds.

- The ZOOM mode may be automatically changed by the control signal from an external device. When you want to return to the previous ZOOM mode, choose the ZOOM mode again.

## ■ Adjusting the visible area of the picture

If subtitles or the top (or bottom) of the picture are cut off, you can adjust the visible area of the picture manually.

### 1 Press the **ZOOM** button

The ZOOM menu appears.

### 2 Press the **OK** button to display the **ZOOM mode indicator**



The indicator appears.



### 3 While it is displayed, press the **▼/▲** buttons to change the position of the picture

- You cannot adjust the visible area in REGULAR or FULL mode.

The visible area adjustment is saved even after the TV channel is changed. However, it is cancelled if the following operations are performed.

- The power is turned off/on
- The ZOOM mode is changed
- The  (Multi) button,  (Freeze) button, or  (Text) button is pressed
- The TV is switched between TV mode and EXT mode

## 3D SOUND function

You can enjoy sounds with a wider ambience.

- This function does not work for the sound from headphones.

### Press the button to select one of 3D SOUND modes

#### HIGH/LOW:

When you listen to stereo sound, please select HIGH or LOW mode.

You can enjoy sound similar to the experience at the theatre.

When you combine the functions of A.H.B. and BBE, you can enjoy more powerful sound.

- When you set the 3D SOUND function to HIGH mode, there may be slight volume distortion. If that occurs, please switch to LOW mode. The effect of 3D SOUND functions will be less noticeable, but the volume distortion will be corrected.

#### MONO:

Select the MONO mode, when you listen to the mono sound.

You can enjoy the sound for a wider audience similar to stereo sound.

#### OFF:

The 3D SOUND function switches off.

- You can choose the 3D SOUND mode with the “SOUND menu” (see page 33).

## Return to TV channel instantly

You can return to a TV channel instantly.

### Press the **TV** button

The TV returns to the TV mode and a TV channel appears.

## Using the “Freeze” function

You can view the current programme as a still picture.

### 1 Press the button

The still picture of the current picture will appear.

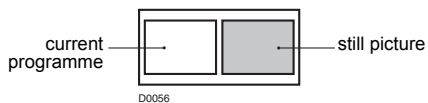

### To cancel the “Freeze” function:

Press the  button, the **P**  $\vee/\wedge$  buttons or the number buttons.

- The “Freeze” function does not work while a sub-picture is displayed.
- The still picture cannot be output from the TV.
- The “Freeze” function does not work for picture of PC signal.

## Using the “Multi-picture” function

### 1 Press the button

The “Multi-picture” menu appears.



### 2 Press the $\leftarrow/\rightarrow$ buttons to choose the number of screens and then press the OK button

 Choose to return to one screen.  
D0102

 Choose to change to 2-pictures multi.  
D0103

 Choose to change to 12-pictures multi.  
D0104

### 2-pictures multi:

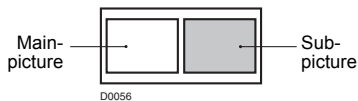

With 1125i and 750p signals, the screen is split into two as shown below.

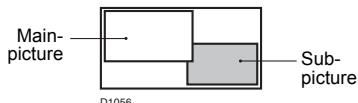



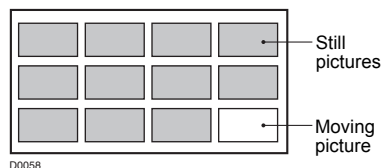



### 12-pictures multi:

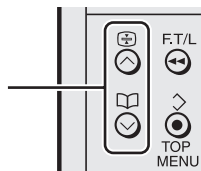



- When set to 2-pictures multi, you can view a TV picture and a picture from an external device. You cannot view a TV picture on more than one screen at the same time.
- When 12-pictures multi is set, pictures from external devices are not displayed.
- When set to 2-pictures multi, the main-picture can be changed by pressing the **P**  $\vee/\wedge$  buttons. The sub-picture screen can be changed by pressing the  $\vee/\wedge$  buttons.  
When set to 12-pictures multi and there are more than 12 pictures, the next or previous 12 screens can be displayed by pressing the  $\vee/\wedge$  buttons.

Changing the sub-picture  
Displaying the next or  
previous 12 screens



- When set to 2-pictures multi, the main-picture sound from the TV speaker can be changed to the sub-picture sound by pressing the  button. (The speaker mark moves from the main-picture to the sub-picture.)  
The sound changes to the main-picture sound if the  button is pressed again. When the headphones are connected, you can listen to the sound from the side at which the speaker mark is displayed. No sound comes from the TV speaker.
- A picture of EXT-4 cannot be displayed as the sub-picture.
- The “Multi-picture” function does not work for a PC signal.
- You cannot view a scrambled channel in the sub-picture.
- When set to 12-pictures multi, press the / / /  buttons to choose the screen you want to view and then press the **OK** button to display that picture on the whole screen.
- The BLUE BACK function does not work when the “Multi-picture” function is being used.
- The ZOOM function does not work when the “Multi-picture” function is being used.

**To return the “Multi-picture” to one screen:**

Press the  button, press the /  buttons to choose one screen, and then press the **OK** button.

- Pressing the **TV** button will also return the display to one screen.

---

## Favourite channel function

---

You can register your favourite TV channels (PR 1 – PR 99) in the number buttons 1 to 4. After registering, the channel can be called by pressing the  (favourite) button and a number button 1 to 4.

### ■ Favourite channel registration

#### 1 In the normal screen, choose a TV channel (PR 1 – PR 99) that you want to register

For details, refer to “Choose a TV channel and watch images from external devices” on page 16.

#### 2 Press and hold the (favourite) button for three seconds or more

Then “SET 1-4?” appears on the screen.

#### 3 Press one of the number buttons 1 to 4

The current channel is registered in the pressed number button.

After “PROGRAMMED!” appears on the screen, the favourite channel icon appears at the top-right of the screen.

- If the channel you are trying to register is already registered in one of the other number buttons 1 to 4, “NOT AVAILABLE” appears on the screen.
- Channels locked with the CHILD LOCK function cannot be registered.
- If AUTO PROGRAM is performed, the registered favourite channels are reset.

- 
- When you want to delete a favourite channel, delete the set channel and set contents with FAVOURITE SETTING (see page 36) in the FEATURES menu.
- 

### ■ Calling the favourite channel

#### 1 In the normal screen, press the (favourite) button

Then “FAVORITE1-4?” appears.

#### 2 Press one of the number buttons 1 to 4

The called favourite channel appears on the screen.

- If a number button in which no channel is registered is pressed, “NO MEMORY” appears on the screen.

### ■ Setting the picture effect

When a favourite channel has been chosen with the  (favourite) button and number buttons 1 to 4, picture effect settings can be memorised for each favourite channel by setting the picture effects in the PICTURE menu (see page 29).

The following items in the PICTURE menu (see page 29) are memorised.

PICTURE MODE

BRIGHT-1

CONTRAST

BRIGHT-2

SHARP

COLOUR

HUE

COLOUR TEMP.

DIGITAL VNR

COLOUR SYSTEM

The last setting made for each item is memorised.

---

## Operating a JVC brand VCR or DVD player

---

These buttons will operate a JVC brand VCR or DVD player. Pressing a button that looks the same as the device's original remote control button has the same effect as the original remote control.

### 1 Set the VCR/TV/DVD Switch to the VCR or DVD position

#### VCR:

When you are operating the VCR, set the switch to the VCR position.

- You can turn the VCR on or off with the  $\odot/I$  (standby) button.

#### DVD:

When you are operating the DVD player, set the switch to the DVD position.

- You can turn the DVD player on or off with the  $\odot/I$  (standby) button.
- You can also press the **MENU** or **TOP MENU** button and display the DVD disc menu screen, and then operate by pressing the  $\blacktriangleleft/\blacktriangleright/\blacktriangledown/\blacktriangleup$  buttons.

---

### 2 Press the VCR/DVD Control Button to control your VCR or DVD player

- If your device is not made by JVC, these buttons will not work.
- Even if your device is made by JVC, some of these buttons may not work, depending on the device you are using.
- You can use the  $\vee/\wedge$  buttons to choose a TV channel the VCR will receive, or choose the chapter the DVD player plays back.
- Some models of DVD player use the  $\vee/\wedge$  buttons for both operating the fast forward/backward functions and for choosing the chapter. In this case, the  $\blacktriangleleft/\blacktriangleright$  buttons do not work.

You cannot turn the TV on or off when the VCR/TV/DVD switch is set to the VCR or DVD position.

When you turn the TV on or off, set the VCR/TV/DVD switch to the TV position.



# Teletext function

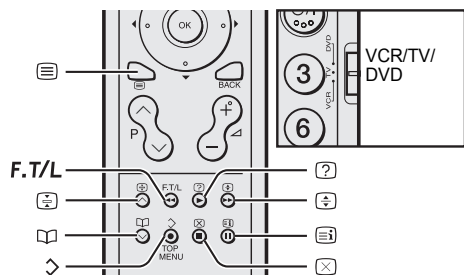

- 4 Choose a teletext page by pressing the **P**  $\nabla/\wedge$  buttons, number buttons or colour buttons

## To return to the TV mode:

Press the **TV** button or (Text) button.

- If you have trouble receiving teletext broadcasts, consult your local dealer or the teletext station.
- The ZOOM function will not work in the TV and text mode or Text mode.
- You cannot operate menus when viewing a teletext programme.
- Language display depends on the country which was set on the COUNTRY menu. If characters on a Teletext programme do not appear properly, change the COUNTRY setting to other country's. To change the COUNTRY setting, perform steps 1 and 2 of the "AUTO PROGRAM" procedure on page 37 and then press the **OK** button.

## Basic operation

- 1 Choose a TV channel with a teletext broadcast
- 2 Set the VCR/TV/DVD switch to the TV position



- 3 Press (Text) button to display the teletext

Pressing (Text) button changes the mode as follows:

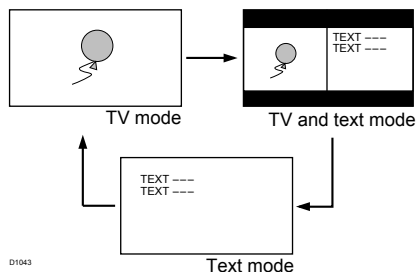

## Using the List Mode

You can store the numbers of your favourite teletext pages in memory and call them up quickly using the colour buttons.

- To store the page numbers:

- 1 Press **F.T/L** button to go into the List mode

The page numbers you have stored are displayed at the bottom of the screen.

- 2 Press a colour button to choose a position. Then press the number buttons to enter the page number**

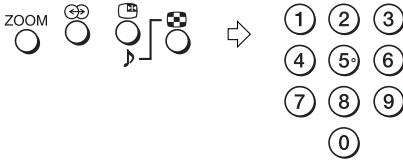

- 3 Press and hold down the  $\diamond$  (Store) button**

The four page numbers blink white to show that they are stored in memory.

■ **To call up a stored page:**

- 1 Press the F.T/L button to enter the List mode**

- 2 Press a colour button having a stored page**

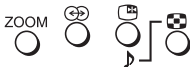

**To exit the List mode:**

Press the F.T/L button again.

## Hold

You can hold a teletext page on the screen for as long as you want, even while several other teletext pages are being received.

- Press the  $\square$  (Hold) button**

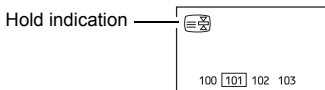

**To cancel the Hold function:**

Press  $\square$  (Hold) button again.

## Sub-page

Some teletext pages include sub-pages that are automatically displayed.

- 1 Choose a teletext page that includes sub-pages**

Sub-page numbers that can be viewed are automatically displayed at the top of the screen.

- 2 Press the  $\blacktriangleleft/\blacktriangleright$  buttons to choose a sub-page number**

## Reveal

Some teletext pages include hidden text (such as answers to a quiz).

You can display the hidden text.

- Each time you press the  $\square$  (Reveal) button, text is hidden or revealed**

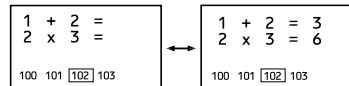

## Size

You can double the height of the teletext display.

- Press the  $\updownarrow$  (Size) button**

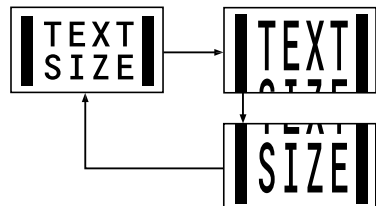

---

## Index

---

You can return to the index page instantly.

---

### **Press the (Index) button**

Returns to page 100 or a previously specified page.

---

---

## Cancel

---

You can search for a teletext page while watching TV.

---

### **1 Press the number button to enter a page number, or press a colour button**

The TV searches for a teletext page.

---

### **2 Press (Cancel) button**

The TV programme appears. When the TV finds the teletext page, its page number appears in the upper left of the screen.

---

### **3 Press (Cancel) button to return to a teletext page when the page number is on the screen**

- The TV mode cannot be resumed by pressing the  (Cancel) button. To return to the TV mode press **TV**.

# Using the TV's menu

This TV has a number of functions you can operate using menus. To use all your TV's functions, you need to understand the basic menu operating techniques fully.

## Buttons used to operate the menus

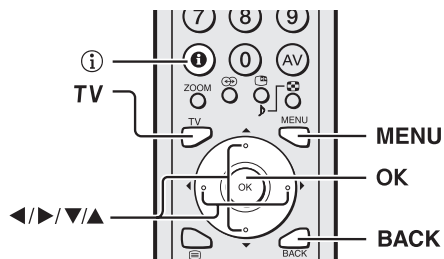

## Basic operation

- 1 Press the **MENU** button to display the menu bar



- 2 Press the **◀/▶** buttons to choose the menu you want to use and then press the **OK** button



- 3 Press the **▼/▲** buttons to choose the item to be set, press the **◀/▶** buttons to set the item, and then press the **OK** button

If there are sub-menus, use the **◀/▶/▼/▲** buttons to operate them.

- Press the **BACK** button to return to the previous menu.
- Press the **TV** or **MENU** button to exit from the menu.
- Some menu items may not be operated or set depending on the TV status or other menu item settings. Menu items that cannot be operated or set are displayed in grey in the menu and cannot be chosen.

## Types of menu



**PICTURE menu**  
Choose to set the screen settings.



**SOUND menu**  
Choose to set the sound settings.



**FEATURES menu**  
Choose to set the sleep timer and child lock settings.



**SET UP menu**  
Choose to edit the channels or set the display language settings.

- The menu will disappear after about one minute if no operation is performed.

The menu guide area can be made to appear and disappear for some menus.

While the menu is displayed, press the **i** button to change between the guide area being displayed and not displayed.

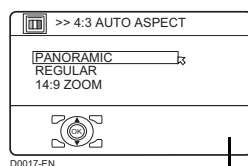

Guide area

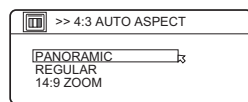

- The guide area for some menus will still be displayed even if the **i** button is pressed. This is not a fault.

### Operation with the buttons on the TV

You can also operate the menus using the buttons on the front panel of the TV.

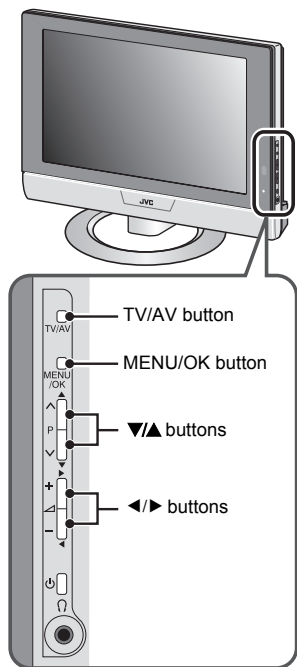

# PICTURE menu

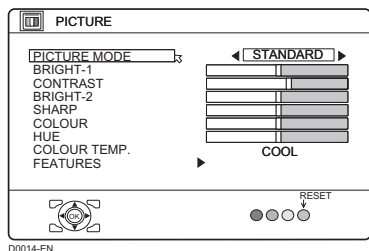

- While the PICTURE menu is displayed, pressing the blue button will set the BRIGHT-1, CONTRAST, BRIGHT-2, SHARP, COLOUR, HUE settings to their default settings.
- When watching the picture from EXT-1 to EXT-4 or the PC, picture effect settings can be memorised for each external input by setting the picture effects in the PICTURE menu.

The following items in the PICTURE menu are memorised.

PICTURE MODE  
BRIGHT-1  
CONTRAST  
BRIGHT-2  
SHARP  
COLOUR  
HUE  
COLOUR TEMP.  
DIGITAL VNR  
COLOUR SYSTEM

The last setting made for each item is memorised.

## PICTURE MODE

You can choose one of three PICTURE MODEs to adjust the picture settings automatically.

### **BRIGHT:**

Heightens contrast and sharpness.

### **STANDARD:**

Standardizes picture adjustment.

### **SOFT:**

Softens contrast and sharpness.

## BRIGHT-1

You can adjust the back light.

- ◀ : darker
- ▶ : brighter

## CONTRAST

You can adjust the picture contrast.

- ◀ : lower
- ▶ : higher

## BRIGHT-2

You can adjust the picture brightness.

- ◀ : darker
- ▶ : brighter

## SHARP

You can adjust the picture sharpness.

- ◀ : softer
- ▶ : sharper

## COLOUR

You can adjust the picture colour.

- ◀ : lighter
- ▶ : deeper

## HUE

You can adjust the picture tint.

- ◀ : reddish
- ▶ : greenish
- You can change the HUE setting (picture hue) when the colour system is NTSC 3.58, or NTSC 4.43.

## COLOUR TEMP.

You can select one of three COLOUR TEMP. modes (three tones of white) to adjust the white balance of the picture. Since white is the colour which is used as a reference for all the other colours, changing the COLOUR TEMP. mode affects the appearance of all the other colours on the screen.

**COOL:**

A bluish white. Using this mode when watching bright pictures allows you to enjoy a more vivid and bright picture.

**NORMAL:**

The normal white colour.

**WARM:**

A reddish white. Using this mode when watching films allows you to enjoy colours that are characteristic of films.

**FEATURES**

Choose FEATURES and press the **OK** or ► button to display the sub-menu.

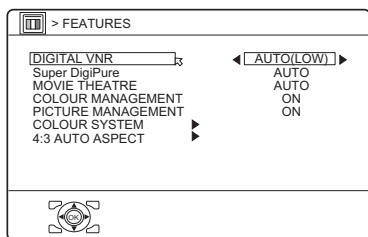

D1015-EN

■ **DIGITAL VNR**

The DIGITAL VNR function cuts down the amount of ‘noise’ (‘snow’ or interference) in the original picture.

You can choose from the three DIGITAL VNR function settings of AUTO, MIN and MAX.

**AUTO(LOW)/AUTO(HIGH):**

The TV will automatically adjust the level of the DIGITAL VNR effect to match the amount of noise in the picture, giving you the best possible picture.

- If you set the DIGITAL VNR effect too high it can make the picture less sharp. It is recommended you use the AUTO(LOW) setting if you can. If you set the DIGITAL VNR function to AUTO(LOW) but still notice some noise, change the setting from AUTO(LOW) to AUTO(HIGH).

**MIN:**

The level of the DIGITAL VNR effect is set to the minimum. If you set the DIGITAL VNR function to AUTO(LOW) but feel that the sharpness of the original picture has not been reproduced fully, change the setting from AUTO(LOW) to MIN.

- The MIN setting is not suitable for low-quality pictures which contain a lot of noise.

**MAX:**

The level of the DIGITAL VNR effect is set to the maximum. If you set the DIGITAL VNR function to AUTO(HIGH) but still notice some noise, change the setting from AUTO(HIGH) to MAX.

- The MAX setting is not suitable for high-quality pictures which contain very little noise.

■ **Super DigiPure**

The Super DigiPure function uses the latest in digital technology to give you a natural-looking picture. The Super DigiPure function includes the following two functions.

**DigiPure function:**

This function helps to create a natural-looking picture by eliminating unnecessary edges from high-contrast and crisp images. For images with low-contrast, edges are added to produce a sharper, more detailed picture.

You can choose from the three DigiPure function settings of AUTO, MIN and MAX.

- If you set the DigiPure effect too high on a low-quality picture that contains a lot of noise, this may actually make the noise worse. We recommend you use the AUTO setting if you can.

**Picture motion compensation function:**

This function displays fast-moving pictures (for example, the players or ball in a football game) more smoothly and naturally on the screen.

- The effect level of the picture motion compensation function cannot be changed. The effect level is the same no matter which of the AUTO, MIN or MAX settings is used.

**AUTO:**

The TV will automatically adjust the level of the DigiPure effect to match the amount of noise in the picture, giving the best possible picture.

**MIN:**

The level of DigiPure effect is set to the minimum. When you set the Super DigiPure function to AUTO and notice some noise, change the setting from AUTO to MIN.

- The MIN setting is not suitable for high-quality pictures which contain very little noise.

**MAX:**

The level of DigiPure effect is set to the maximum. If you set the Super DigiPure function to AUTO but feel that the original picture quality has not been reproduced fully, change the setting from AUTO to MAX.

- The MAX setting is not suitable for low-quality pictures which contain a lot of noise.

**OFF:**

The Super DigiPure function is turned off.

**■ MOVIE THEATRE**

The MOVIE THEATRE function displays a cinema film picture more smoothly and naturally on the screen.

**AUTO:**

The television automatically recognizes the type of signal and turns the function on and off.

**ON:**

This function is turned on.

**OFF:**

This function is turned off.

**■ COLOUR MANAGEMENT**

This TV supports the COLOUR MANAGEMENT function to ensure dull colours are compensated to produce natural hues.

The COLOUR MANAGEMENT function is on by default.

**ON:**

COLOUR MANAGEMENT function is turned on.

**OFF:**

COLOUR MANAGEMENT function is turned off.

- 
- Set this function to ON under normal conditions.
- 

**■ PICTURE MANAGEMENT**

The PICTURE MANAGEMENT function makes it easier to see the dark areas when a picture has many dark areas, and makes it easier to see the bright areas when a picture has many bright areas.

Normally use with this function on.

**ON:**

PICTURE MANAGEMENT function is turned on.

**OFF:**

PICTURE MANAGEMENT function is turned off.



## ■ COLOUR SYSTEM

The colour system is chosen automatically. However, if the picture is not clear or no colour appears, choose the colour system manually.

### 1 Choose COLOUR SYSTEM. Then press the OK or ► button

The sub-menu of the COLOUR SYSTEM function appears.

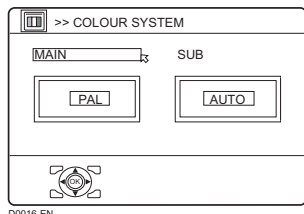

### 2 Press the ◀/▶ buttons to choose MAIN or SUB

#### MAIN:

You can change the colour system of the main-picture.

#### SUB:

You can change the colour system of the sub-picture.

- Choose MAIN when a sub-picture is not displayed.

### 3 Press the ▼/▲ buttons to choose the appropriate colour system. Then press the OK button

#### PAL:

PAL system

#### SECAM:

SECAM system

#### NTSC 3.58:

NTSC 3.58 MHz system

#### NTSC 4.43:

NTSC 4.43 MHz system

#### AUTO:

This function detects a colour system from the input signal. You can only use this when you are viewing a picture from programme number PR 0 (AV), or an EXT terminal.

- The AUTO function may not function properly if you have poor signal quality. If the picture is abnormal in the AUTO function, choose another colour system manually.
- When in the Programme numbers PR 0 (AV) to PR 99, you cannot choose NTSC 3.58 or NTSC 4.43.
- COLOUR SYSTEM cannot be chosen when you are watching the EXT-4 picture or PC picture.

## ■ 4:3 AUTO ASPECT

You can choose one of three ZOOM modes, REGULAR, PANORAMIC or 14:9 ZOOM, as the ZOOM mode for the normal picture (4:3 aspect ratio).

### 1 Choose 4:3 AUTO ASPECT then press the OK button

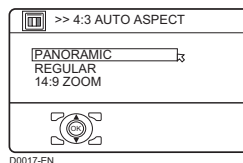

### 2 Press the ▼/▲ buttons to choose a ZOOM mode

# SOUND menu

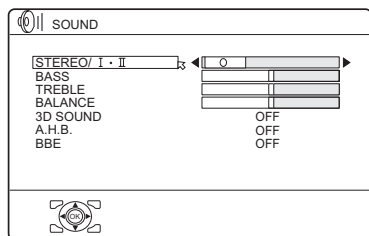

D0019-EN

- When the headphones are connected, only “STEREO / I · II” can be used.

## STEREO / I · II

When you are viewing a bilingual broadcast programme, you can choose the sound from Bilingual I (Sub I) or Bilingual II (Sub II). If you have poor reception on a stereo broadcast, you can change from stereo to mono sound so that you can hear the broadcast more clearly and easily.

⊕: Stereo sound

○: mono sound

I : Bilingual I (sub I)

II : Bilingual II (sub II)

- The sound mode you can choose differs depending on the TV programme.
- This function does not work in the EXT modes.

## BASS

You can adjust the low tone of the sound.

◀: weaker

▶: strong

## TREBLE

You can adjust the high tone of the sound.

◀: weaker

▶: strong

## BALANCE

You can adjust the volume balance between the left and right speaker.

◀: turn the left speaker's volume level up.

▶: turn the right speaker's volume level up.

## 3D SOUND

You can enjoy Surround sound with a “live” effect by using the 3D SOUND function.

- You can choose a 3D SOUND mode from HIGH, LOW, MONO and OFF modes. For details, see “3D SOUND function” on page 19.
- You can also operate the 3D SOUND function with the  button. For details, see “3D SOUND function” on page 19.

## A.H.B. (Active Hyper Bass)

Used when you want to emphasize the bass sound.

**ON:**

This function is turned on.

**OFF:**

This function is turned off.

## BBE

BBE function restores clarity and presence for better speech intelligibility and musical realism.

**ON:**

This function is turned on.

**OFF:**

This function is turned off.

- Manufactured under license from BBE Sound, Inc. Licensed by BBE Sound, Inc. under USP4638258, 5510752 and 5736897. BBE and BBE symbol are registered trademarks of BBE Sound, Inc.

# FEATURES menu

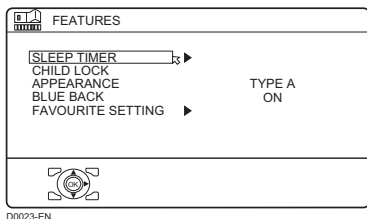

## SLEEP TIMER

You can set the TV to automatically turn off after a set period of time.

### 1 Choose SLEEP TIMER. Then press the OK or ► button

A Sub-menu of the SLEEP TIMER function appears.

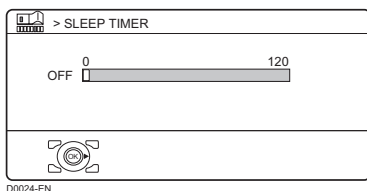

### 2 Press the ◀/▶ buttons to set the period of time. Then press the OK button

You can set the period of time for up to 120 minutes (2 hours) in 10 minute steps.

- One minute before the SLEEP TIMER function turns off the TV, “GOODNIGHT!” appears.
- The SLEEP TIMER function cannot be used to turn off the TV’s main power.
- When the SLEEP TIMER function is on, you can display the sub-menu of the SLEEP TIMER function again to confirm or change the remaining period of time of the SLEEP TIMER function. Press the OK button to leave the menu after confirming or changing the remaining time.

### To cancel the SLEEP TIMER function:

Press the ◀ button to set the period of time to “OFF”.

## CHILD LOCK

When there is a TV channel you do not want your children to watch, you can use the CHILD LOCK function to lock out the TV channel. Even when a child chooses a programme number (PR) for a locked TV channel the screen will change to blue and display  (CHILD LOCK) so the TV channel cannot be viewed. Unless you enter a pre-set ID number by a special operation, the lock cannot be released and the child cannot view the TV channel.

### ■ To set the CHILD LOCK function

#### 1 Choose CHILD LOCK, then press the 0 button

“SET ID NO.” (ID number setting screen) appears.

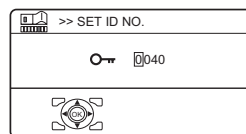

#### 2 Set the ID number to your liking

1 Press the ▼/▲ buttons to choose a number.

2 Press the ◀/▶ buttons to move the cursor.

#### 3 Press the OK button

The Sub-menu of CHILD LOCK appears.

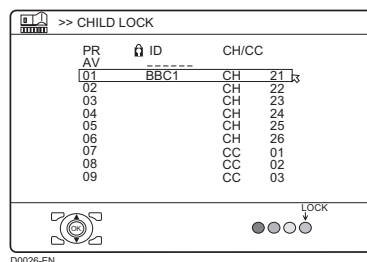

#### 4 Press the ▼/▲ buttons to choose a TV channel

Every time you press the ▼/▲ buttons, the Programme number (PR) changes, and the picture of the TV channel registered in the Programme number (PR) is displayed on the screen.

#### 5 Press the blue button and set the CHILD LOCK function. Then press the OK button

🔒 (CHILD LOCK) appears and the TV channel is locked.

##### To reset the CHILD LOCK function:

Press the blue button again.

🔒 (CHILD LOCK) disappears.

To disable easy resetting of the CHILD LOCK function, the menu disappears if you choose the CHILD LOCK function and press the OK button.

### ■ To view a locked TV channel

#### 1 Choose a programme number (PR) of a locked TV channel with the number buttons or PR LIST

The screen changes to blue and the 🔒 (CHILD LOCK) appears. You cannot view the TV channel.



D0027-EN

#### 2 Press the ⓘ (Information) button to display "ID NO." (ID No. input screen)

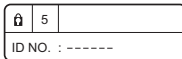

D0028-EN

#### 3 Press the number buttons to enter the ID number

The lock is temporarily released so you can view the TV channel.

#### If you have forgotten the ID number:

Perform step 1 of "To set the CHILD LOCK function". After confirming the ID number, press the TV button to exit the menu.

- Even if you reset the lock temporarily, it does not mean that the CHILD LOCK function set for the TV channel is cancelled. The next time anyone tries to view the TV channel, it will be locked again.
- When you want to cancel the CHILD LOCK function, you must perform the operation "To set the CHILD LOCK function" again.
- To stop it being easy to choose the programme number (PR) of a locked TV channel, the programme number (PR) has been set so that it cannot be chosen with the ▼/▲ buttons or the buttons of the TV.
- To stop it being easy to reset the lock, "ID NO." (ID No. input screen) is set so that it cannot appear unless you press the ⓘ (Information) button.

## APPEARANCE

Press the ◀/▶ button and choose the format in which the channel number is displayed from the four types: TYPE A, TYPE B, TYPE C, and TYPE D.

- Set to TYPE D when shipped from factory. TYPE D sets all screens to semitransparent. The menu screens are not semitransparent when set to a type other than TYPE D.

## BLUE BACK

You can set the TV to automatically change to a blue screen and mute the sound if the signal is weak or absent, or when there is no input from an external device.

##### ON:

This function is turned on.

##### OFF:

This function is turned off.

---

## FAVOURITE SETTING

---

Chose when deleting the favourite channels registered in the buttons 1 to 4.

---

### 1 Choose FAVOURITE SETTING, then press the OK or ► button

The FAVOURITE SETTING menu appears.

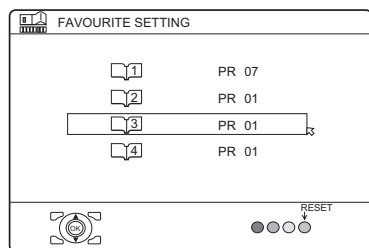

D0112-EN

---

### 2 Press the ▼/▲ buttons and chose the favourite channel that you want to delete

---

### 3 Press the blue button

The chosen favourite channel and set contents are deleted.

- 
- For details of the favourite channels, see “Favourite channel function” on page 22.
-

# SET UP menu

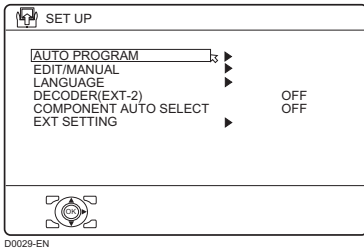

## AUTO PROGRAM

You can again perform the AUTO PROGRAM function TV channel automatic registration which was performed in the “Initial settings” (page 8).

### 1 Choose AUTO PROGRAM, then press the OK or ► button

The COUNTRY menu appears as a sub-menu of the AUTO PROGRAM function. There are two COUNTRY menus. Pressing the yellow button changes the COUNTRY menu as follows:

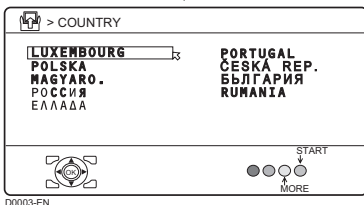
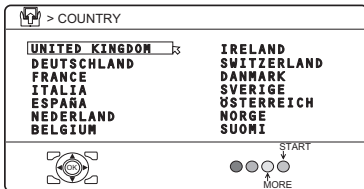

### 2 Press the ◀/▶ and ▼/▲ buttons to choose the country where you are

### 3 Perform steps 5 and 6 of the “Initial settings” (page 9)

## EDIT/MANUAL

The EDIT/MANUAL functions are divided into two types:

- editing the current programme numbers (PR) (EDIT functions); and
- manually storing a TV channel you want to view on a particular programme number (PR) (MANUAL function).

Here are the details about these functions:

### MOVE:

This function changes the programme number (PR) of a TV channel.

### ID:

This function registers a channel name (ID) to a TV channel.

### INSERT:

This function adds a new TV channel in the current programme numbers (PR) list by using the CH/CC number.

- You cannot use the INSERT function if you do not know the channel number of a TV channel. Use the MANUAL function to register a TV channel in the programme number (PR).

### DELETE:

This function deletes a TV channel you do not want to list.

### MANUAL:

This function manually stores a new TV channel in a programme number (PR).

## Caution

- Using the MOVE, DELETE or INSERT functions rewrites the current programme numbers (PR) list. Therefore, the programme numbers (PR) of some of the TV channels will change.
- Using the MANUAL function for a TV channel for which the CHILD LOCK function has been set cancels the CHILD LOCK function for that channel.

- Using the MANUAL function for a TV channel for which the DECODER (EXT-2) function has been set to ON returns the setting of the DECODER (EXT-2) function for that channel to OFF.
- When a TV channel has already been registered in PR 99, using the INSERT function deletes that TV channel.

## ■ Basic operation

### 1 Choose EDIT/MANUAL, then press the OK or ► button

The EDIT menu appears.

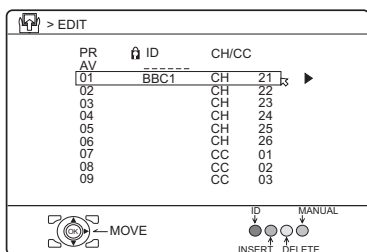

D0038-EN

### 2 Follow the description for the function you want to use

### 3 Press the OK button to complete the settings

The T-V LINK menu appears.

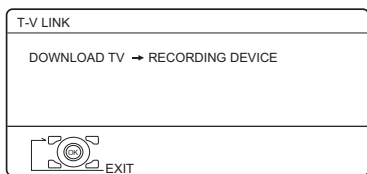

D0005-EN

### If you do not have a T-V LINK compatible VCR connected:

Press the TV button to exit the T-V LINK menu.

The T-V LINK menu disappears.

### If you have a T-V LINK compatible VCR connected to the EXT-2 terminal:

Follow “Downloading the data to VCR” on page 11 to transmit the programme number (PR) data.

- For programme number PR 0, “AV” appears in the programme numbers (PR) list.
- An EXT terminal number does not appear in the programme numbers (PR) list.

## ■ MOVE

### 1 Press the ▼/▲ buttons to choose a TV channel

### 2 Press the ► button to start the MOVE function

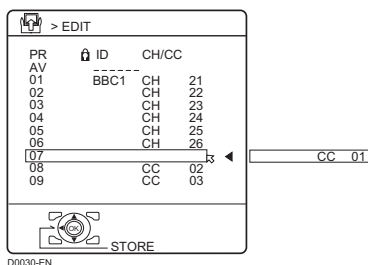

D0030-EN

### 3 Press the ▼/▲ buttons to choose a new programme number (PR)

To cancel the MOVE function:  
Press the BACK button.

### 4 Press the ◀ button to change the programme number (PR) of a TV channel to a new programme number (PR)

## ■ DELETE

### 1 Press the ▼/▲ buttons to choose a TV channel

### 2 Press the yellow button to delete the TV channel

The TV channel is deleted from the programme numbers (PR) list.

## ■ ID

1 Press the **▼/▲** buttons to choose a TV channel

2 Press the red button to start the ID function

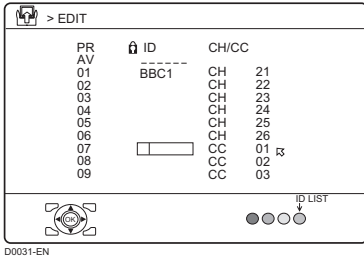

3 Press the **▼/▲** buttons to choose the first character of a channel name (ID) you want to give the TV channel

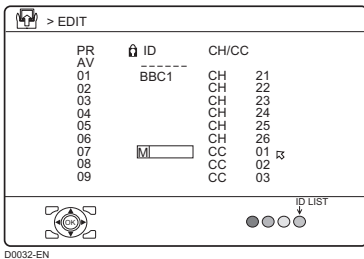

4 Press the blue button to display the ID LIST (channel name list)

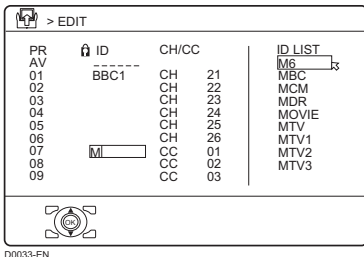

5 Press the **▼/▲** buttons to choose the channel name (ID)

To cancel the ID function:

Press the **BACK** button.

6 Press the **OK** button to give a channel name (ID) to a TV channel

- You can give your own unique channel name (ID) to the TV channel. When you have finished step 3, do not go to step 4. Press the **◀/▶** buttons to move the cursor, and press the **▼/▲** buttons to choose each character of the channel name (ID). Then press the **OK** button to register the channel name (ID) to the TV channel.

Before performing **INSERT** or **MANUAL** operation

- If you register the TV channel (SECAM-L system) from a French station, be sure to set the **COUNTRY** setting to **FRANCE**. If the **COUNTRY** setting is not set to **FRANCE**, perform steps 1 and 2 of the “**AUTO PROGRAM**” (page 37) procedure and set the **COUNTRY** setting to **FRANCE** before pressing the **OK** button.
- A **CH/CC** number unique to this TV and corresponding to the Channel number of a TV channel is required. Find the corresponding **CH/CC** number from a table “**CH/CC numbers**” on page 50 based on the Channel number of the TV channel.
- When the **COUNTRY** setting is not **FRANCE**, use a two-digit **CH/CC** number. When the **COUNTRY** setting is **FRANCE**, use a three-digit **CH/CC** number.



## ■ INSERT

1 Press the ▼/▲ buttons to choose a programme number (PR) for which you will register a new TV channel

2 Press the green button and start the INSERT function

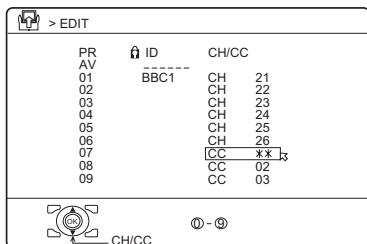

**To cancel the INSERT function:**  
Press the **BACK** button.

3 Press the ▼/▲ buttons to choose "CH" or "CC", then enter the remaining CH or CC number

**When the COUNTRY setting is FRANCE:**

Choose "CH1", "CH2", "CC1" or "CC2".

The TV shifts to registration mode.

When the registration is completed, the picture of the TV channel appears on the screen.

- The CH/CC number is a number given to each broadcast frequency that carries a TV channel. If the TV cannot detect the TV channel corresponding to the broadcast frequency indicated by the CH/CC number, a "no-signal" picture appears.

## ■ MANUAL

1 Press the ▼/▲ buttons to choose a programme number (PR) for a new TV channel

2 Press the blue button to activate the MANUAL function

At the right side following the CH/CC number, the SYSTEM (broadcasting system) of the TV channel appears.

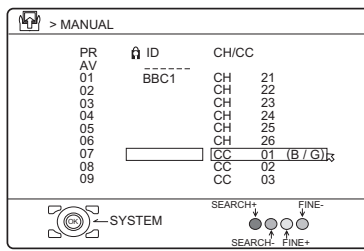

**To cancel the MANUAL function:**  
Press the **BACK** button.

3 Press the ► button to choose the **SYSTEM (broadcasting system)** for a TV channel you want to register

**TV channel (SECAM-L system) from a French station:**

Set the SYSTEM to "L". If it is set to one other than "L", you cannot receive the TV channel of the SECAM-L system.

**Other TV channels:**

If you do not know the correct broadcasting system, set the SYSTEM to "B/G". If "B/G" is not correct, you will not hear the sound normally when the TV detects a TV channel. In this case, retry to set the SYSTEM correctly so that no problem arises.

#### 4 Press the green or red button to search for a TV channel

Scanning stops when the TV finds a TV channel. Then the TV channel is displayed.

#### 5 Press the green or red button repeatedly until the TV channel you want appears

**If the TV channel reception is poor:**  
Press the blue or yellow button to fine-tune the TV channel.

#### 6 Press the OK button and register the TV channel to a Programme number (PR)

The normal EDIT menu is resumed.

## LANGUAGE

The LANGUAGE setting which was performed in the “Initial settings” (page 8) can be changed.

#### 1 Choose LANGUAGE, then press the OK or ► button

A sub-menu of the LANGUAGE function appears.

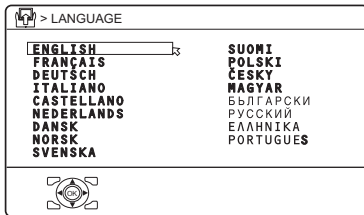

D0002-EN

#### 2 Press the ◀/▶ and ▼/▲ buttons to choose a language. Then press the OK button

## DECODER (EXT-2)

If you have a decoder connected to a T-V LINK compatible VCR, which in turn is connected to the EXT-2 terminal, use the DECODER (EXT-2) function to unscramble the scrambled TV channels.

#### 1 Turn on the decoder power

#### 2 Display the scrambled TV channel on the TV

Even if the decoder is working, a scrambled picture appears.

#### 3 Display the SET UP menu and choose DECODER (EXT-2)

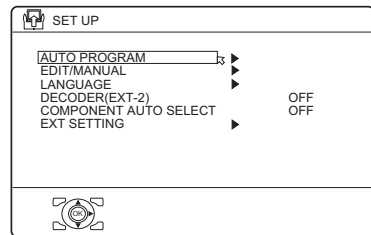

D0029-EN

#### 4 Press the ◀/▶ buttons to choose ON

An unscrambled picture appears.

#### To cancel the DECODER (EXT-2) function:

Press the ◀/▶ buttons to choose OFF.

#### 5 Press the OK button to complete the setting

The T-V LINK menu appears.

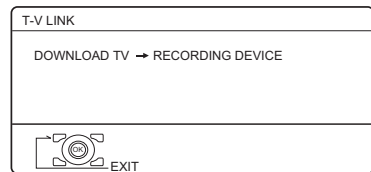

D0005-EN

You can send the programme numbers data to a VCR with the T-V LINK function.

## 6 Turn on the VCR, and then press the OK button to transmit the data to VCR

The T-V LINK menu disappears once the data transmission ends.

If the DECODER (EXT-2) function has been set to “ON” but the TV channel cannot be unscrambled, check the following:

- Has the decoder been connected to the VCR properly according to the VCR and decoder instruction manuals?
- Has the decoder power been turned on?
- Can the TV channel be unscrambled with a decoder?
- Do you need to change the VCR settings in order to connect the decoder? Confirm that the VCR is set properly by rechecking the VCR instruction manual.

## COMPONENT AUTO SELECT

When an external device that can output a component signal is connected to the EXT-4 component terminal and the connected device is played back, the TV input is automatically changed to EXT-4.

### ON:

When the device connected to EXT-4 is played back, the TV input is automatically changed to EXT-4.

### OFF:

Even when the device connected to EXT-4 is played back, the TV input is not changed. (Set to OFF when shipped from the factory.)

- This function automatically changes the TV input to EXT-4 when the TV detects a component input signal from the device connected to the EXT-4.
- When set to ON, the TV input may be automatically changed to EXT-4 just by an operation such as turning the power on, removing a disc, or another operation with a device (such as a DVD player).

## EXT SETTING

### 1 Choose EXT SETTING, then press the OK or ► button

The EXT SETTING menu appears.

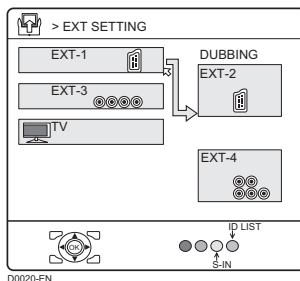

### 2 Follow the instructions for the function you want to use and operate the function

#### S-IN:

You can enjoy the high-quality picture of the S-VIDEO signal (Y/C signal).

#### ID LIST:

You can have a name for each of the devices connected for each EXT terminal.

#### DUBBING:

You can choose a signal source to be output from an EXT-2 terminal.

### ■ S-IN (S-VIDEO input)

You can connect a device (such as an S-VHS VCR) to enjoy the high-quality picture of the S-VIDEO signal (Y/C signal).

#### Preparation:

- First read the device’s instruction manual and “Additional preparation” on page 46 to connect the device to the TV properly. Second, follow the device’s instruction manual to set the device so that it sends an S-VIDEO signal (Y/C signal) to the TV.
- Do not set S-IN (S-VIDEO input) to an EXT terminal connected to a device which cannot output an S-VIDEO (Y/C signal).

### 1 Press the ◀/▶ or ▼/▲ buttons to choose an EXT terminal

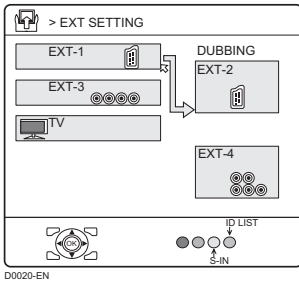

### 2 Press the yellow button and set the S-IN (S-VIDEO input). Then press the OK button

An S-IN (S-VIDEO input) mark is displayed. You can view an S-VIDEO signal (Y/C signal) instead of the regular video signal (composite signal).

#### To cancel the S-IN (S-VIDEO input) setting:

Press the yellow button and turn off S-IN (S-VIDEO input) mark. The regular video signal (composite signal) pictures are resumed.

- Setting S-IN (S-VIDEO input) changes the head character from “E” to “S”. When an EXT terminal receives a normal video signal, “E1”, “E2” or “E3” appears on the display. This changes to “S1”, “S2” or “S3” when it receives an S-VIDEO signal.
- Even a device which can output an S-VIDEO signal (Y/C signal) may output a regular video signal (composite signal) depending on the device setting. If a picture cannot appear because the S-IN (S-VIDEO input) setting has been made, read the device instruction manual carefully again to check for the device settings.

### ■ ID LIST

You can store a name for each of the devices connected to each EXT terminal. Giving a name to an EXT terminal makes the EXT terminal number appear on the screen, together with its name.

### 1 Press the ◀/▶ or ▼/▲ buttons to choose an EXT terminal

### 2 Press the blue button to display the name list (ID LIST)

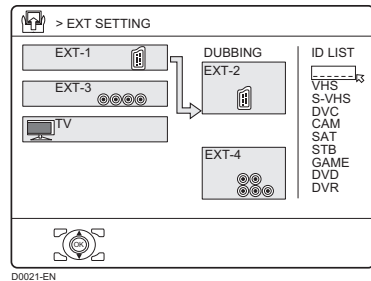

### 3 Press the ▼/▲ buttons to choose a name. Then press the OK button

The ID LIST disappears and the name is assigned to the EXT terminal.

- You cannot assign an EXT terminal name not found in the name list (ID LIST).

#### To erase a name assigned to the EXT terminal:

Choose a blank space.

### 4 Press the OK button to complete the setting

■ **DUBBING**

You can choose a signal source to be output from the EXT-2 terminal.

You can do this with the output signals of the devices connected to other EXT terminals, or with the picture and sound from a TV channel you are currently viewing.

**1 Press the ◀/▶ buttons to choose the arrow from the menu**

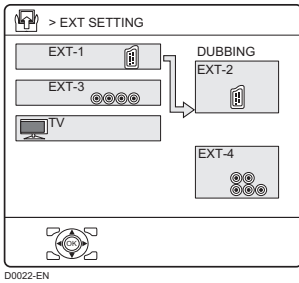

**2 Press the ▼/▲ buttons to choose an EXT terminal or TV. Then press the OK button**

The arrow in the menu represents a signal flow. The left side of the arrow shows a signal source output from the EXT-2 terminal.

**EXT-1/EXT-3:**

The output signal of the device connected to an EXT terminal passes through the TV and is output from the EXT-2 terminal.

**TV:**

The picture and sound of the TV channel you are currently viewing are output from the EXT-2 terminal.

- During dubbing, you cannot turn off the TV. Turning off the TV also turns off the output from the EXT-2 terminal.
- When you choose an EXT terminal as an output, you can view a TV programme or a picture from the other EXT terminal while dubbing the picture from a device connected to the EXT terminal onto a VCR connected to the EXT-2 terminal.
- The RGB signals from TV games cannot be output. Teletext programmes cannot be output.

# Displaying a computer screen

This TV can be used as a computer screen.

## Connecting to the computer

Use a D-SUB cable to connect the TV's PC IN terminal to the computer's analogue RGB output terminal.

If you want to listen to the sound from the computer, use an audio cable to connect the EXT-3 L/R terminal to the computer's sound output terminal.

When the sound from the computer is mono, connect to the EXT-3 L terminal.

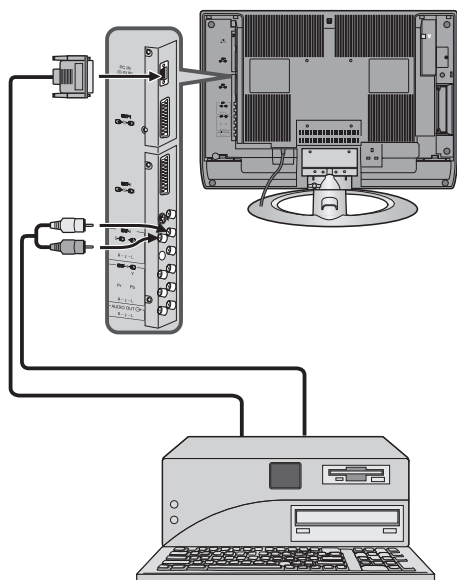

- Refer to the computer manual for a detailed explanation of the connections at the computer side.
- Ensure that the connectors are facing the correct way when connecting.
- After connecting the D-SUB cable, tighten the two screws to fix the connector in place.

## Watching images from a computer

**After starting the computer, press the AV or P V/Λ buttons to choose "PC"**

"PC" is after EXT-4.

You can listen to the sound when the sound from the computer is connected to the EXT-3 L/R terminal.

- When the sound from the computer is connected to EXT-3, by choosing external input EXT-3 the sound from the computer can be listened to, but the images from the computer cannot be seen.

## Table of signals for each type of computer

| Resolution       | Vertical frequency (Hz) | Horizontal frequency (kHz) |
|------------------|-------------------------|----------------------------|
| 640 × 480 (VGA)  | 60.0                    | 31.5                       |
| 1024 × 768 (XGA) | 60.0                    | 42.0                       |

- \* Only the above formats are supported.
- \* Even with the above formats and at 60 Hz, some problems may be experienced depending on the quality of the synchronous signal. (Depending on the quality, some pictures may not be displayed properly.)
- \* Apple Macintosh\* computers are not supported.

### When a picture is not displayed

Check the computer's refresh rate and set it to 60 Hz. Refer to the computer's instruction manual.

Computers which cannot have their refresh rate set to 60 Hz cannot be used with this unit.

- \* Apple Macintosh is a registered trademark of Apple Computer, Inc.

# Additional preparation

---

## Connecting external equipment

---

Connect the equipment to the TV, making the correct rear panel and front panel connections.

### Before connecting anything:

- Read the manuals that came with the equipment.  
Depending on the equipment, the connection method may be different from the diagram. Also, the equipment settings may need to change depending on the connection method.
  - Turn off all the equipment including the TV.
  - The “Specifications” on page 55 give the details of the EXT terminals. If you are connecting equipment not listed in the following connection diagram, see the table to choose the best EXT terminal.
  - Connecting cables are not supplied.
  - When a device that can output component signals is connected to the EXT-4 component terminal, the TV input can be automatically changed to EXT-4 by just turning the power supply of the connected device on. For details, see “COMPONENT AUTO SELECT” in the SET UP menu on page 42.
- **Connecting the PC**  
For details, see “Connecting to the computer” on page 45.

- ① VCR (composite signal)
- ② VCR (composite signal/S-VIDEO signal)
- ③ T-V LINK compatible VCR (composite signal/S-VIDEO signal)
- ④ Decoder
- ⑤ DVD player (composite signal/S-VIDEO signal)
- ⑥ DVD player (composite signal/RGB signal)
- ⑦ DVD player (component video signals; Y/Pb/Pr)
- ⑧ TV game (composite signal/RGB signal)
- ⑨ TV game (composite signal/S-VIDEO signal)
- ⑩ Headphones
- ⑪ Camcorder (composite signal/S-VIDEO signal)
- ⑫ SCART cable
- ⑬ Audio cable
- ⑭ Video cable
- ⑮ S-VIDEO cable
- ⑯ Component cable

without terminal covers

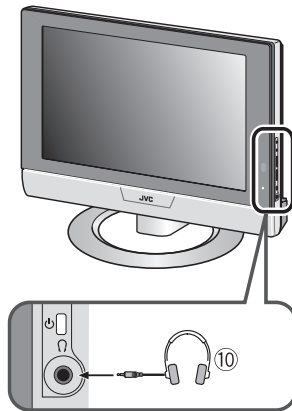
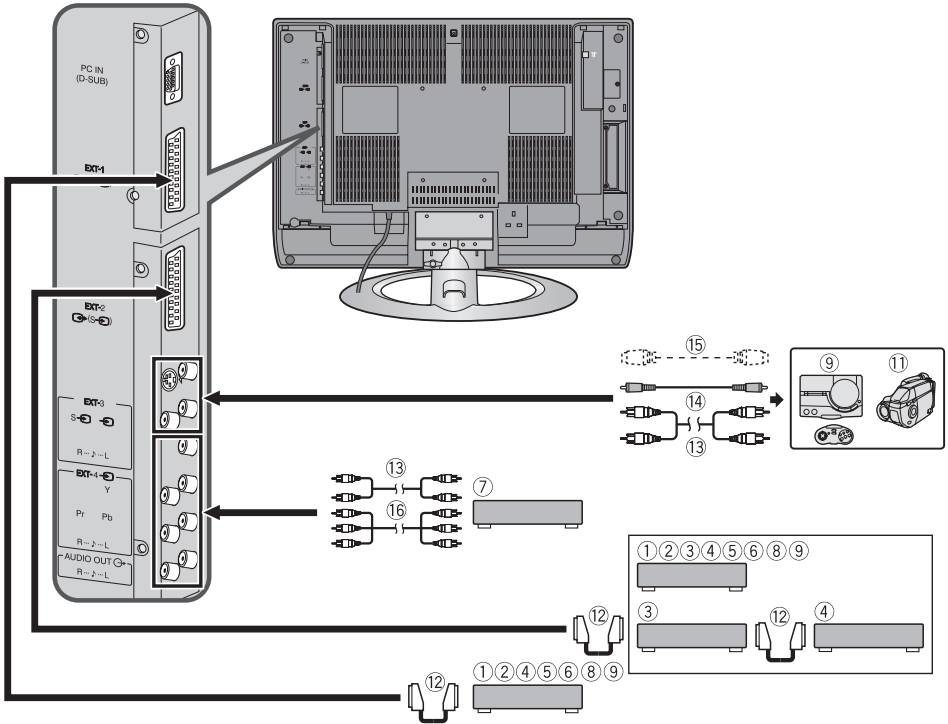



■ **Equipment which can output the S-VIDEO signal (Y/C signal) such as an S-VHS VCR**

Connect the equipment to an EXT terminal other than EXT-4.

You can choose between an S-VIDEO signal (Y/C signal) and a regular video signal (composite signal). For details of how to operate the equipment, see “S-IN (S-VIDEO input)” on page 42.

■ **T-V LINK compatible VCR**

Be sure to connect the T-V LINK compatible VCR to the EXT-2 terminal. If not, the T-V LINK function will not work properly.

- When connecting a T-V LINK compatible VCR to the EXT-2 terminal, be sure to connect the decoder to the VCR. If not, the T-V LINK function may not work properly.
- When you connect the decoder to the VCR, after you have stored TV channels in the programme numbers (PR) list, set the DECODER (EXT-2) function for the programme number (PR) to ON to unscramble a scrambled TV channel. For details, see “DECODER (EXT-2)” on page 41.

■ **Connecting headphones**

Connect the headphones with a stereo mini-jack (3.5 mm diameter) to the headphone socket at the TV rear panel.

- No sound comes from the TV speakers when the headphones are connected.

■ **Video or sound signal output from the EXT-2 terminal**

You can change over the output of the video/sound signal from the EXT-2 terminal. This is useful when you want to dub the video/sound from another device onto the VCR connected to the EXT-2 terminal. For details on how to do this, see “DUBBING” on page 44.

- The signals from EXT-4 and PC IN terminal cannot be output from EXT-2.

■ **TV output from the EXT-1 terminal**

The video/sound signal of a TV channel you are viewing is always output from the EXT-1 terminal.

- Changing over a programme number (PR) also changes over the TV output from the EXT-1 terminal.
- The video/sound signal from an EXT terminal cannot be output.
- Teletext programmes cannot be output.

## ■ Connecting speakers/amplifier

While referring to the audio equipment connection diagram, connect the audio equipment you want to the TV.

You can use external front speakers to listen to the TV sound instead of the TV speakers.

### Before connecting anything:

- Read the manuals provided with the amplifier and speakers.
- Turn the TV and amplifier off.
- Note that connecting cables are not supplied.

without terminal covers

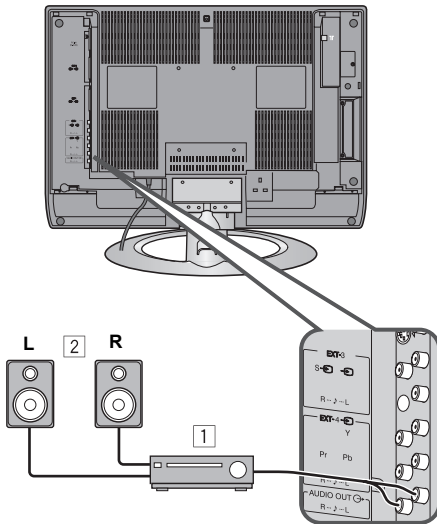

- 1 Amplifier  
2 External speakers (Magnetic-shielded type)

- The output from the AUDIO OUT terminal is not interrupted by headphone connection to the TV. You cannot cut the sound from the front speaker even if you connect a headphone to the TV.
- Adjust the volume of the external speakers with the amplifier.

# CH/CC numbers

When you want to use the INSERT function on page 40, find the CH/CC number corresponding to the Channel number of the TV channel from this table.

| CH             | Channel             | CH             | Channel  | CC             | Channel | CC             | Channel        |
|----------------|---------------------|----------------|----------|----------------|---------|----------------|----------------|
| CH 02 / CH 202 | E2, R1              | CH 40 / CH 240 | E40, R40 | CC 01 / CC 201 | S1      | CC 31 / CC 231 | S31            |
| CH 03 / CH 203 | E3, ITALY A         | CH 41 / CH 241 | E41, R41 | CC 02 / CC 202 | S2      | CC 32 / CC 232 | S32            |
| CH 04 / CH 204 | E4, ITALY B, R2     | CH 42 / CH 242 | E42, R42 | CC 03 / CC 203 | S3      | CC 33 / CC 233 | S33            |
| CH 05 / CH 205 | E5, ITALY D, R6     | CH 43 / CH 243 | E43, R43 | CC 04 / CC 204 | S4      | CC 34 / CC 234 | S34            |
| CH 06 / CH 206 | E6, ITALY E, R7     | CH 44 / CH 244 | E44, R44 | CC 05 / CC 205 | S5      | CC 35 / CC 235 | S35            |
| CH 07 / CH 207 | E7, ITALY F, R8     | CH 45 / CH 245 | E45, R45 | CC 06 / CC 206 | S6      | CC 36 / CC 236 | S36            |
| CH 08 / CH 208 | E8, R9              | CH 46 / CH 246 | E46, R46 | CC 07 / CC 207 | S7      | CC 37 / CC 237 | S37            |
| CH 09 / CH 209 | E9, ITALY G         | CH 47 / CH 247 | E47, R47 | CC 08 / CC 208 | S8      | CC 38 / CC 238 | S38            |
| CH 10 / CH 210 | E10, ITALY H, R10   | CH 48 / CH 248 | E48, R48 | CC 09 / CC 209 | S9      | CC 39 / CC 239 | S39            |
| CH 11 / CH 211 | E11, ITALY H+1, R11 | CH 49 / CH 249 | E49, R49 | CC 10 / CC 210 | S10     | CC 40 / CC 240 | S40            |
| CH 12 / CH 212 | E12, ITALY H+2, R12 | CH 50 / CH 250 | E50, R50 | CC 11 / CC 211 | S11     | CC 41 / CC 241 | S41            |
| CH 21 / CH 221 | E21, R21            | CH 51 / CH 251 | E51, R51 | CC 12 / CC 212 | S12     | CC 75 / CC 275 | X              |
| CH 22 / CH 222 | E22, R22            | CH 52 / CH 252 | E52, R52 | CC 13 / CC 213 | S13     | CC 76 / CC 276 | Y, R3          |
| CH 23 / CH 223 | E23, R23            | CH 53 / CH 253 | E53, R53 | CC 14 / CC 214 | S14     | CC 77 / CC 277 | Z, ITALY C, R4 |
| CH 24 / CH 224 | E24, R24            | CH 54 / CH 254 | E54, R54 | CC 15 / CC 215 | S15     | CC 78 / CC 278 | Z+1, R5        |
| CH 25 / CH 225 | E25, R25            | CH 55 / CH 255 | E55, R55 | CC 16 / CC 216 | S16     | CC 79 / CC 279 | Z+2            |
| CH 26 / CH 226 | E26, R26            | CH 56 / CH 256 | E56, R56 | CC 17 / CC 217 | S17     |                |                |
| CH 27 / CH 227 | E27, R27            | CH 57 / CH 257 | E57, R57 | CC 18 / CC 218 | S18     |                |                |
| CH 28 / CH 228 | E28, R28            | CH 58 / CH 258 | E58, R58 | CC 19 / CC 219 | S19     |                |                |
| CH 29 / CH 229 | E29, R29            | CH 59 / CH 259 | E59, R59 | CC 20 / CC 220 | S20     |                |                |
| CH 30 / CH 230 | E30, R30            | CH 60 / CH 260 | E60, R60 | CC 21 / CC 221 | S21     |                |                |
| CH 31 / CH 231 | E31, R31            | CH 61 / CH 261 | E61, R61 | CC 22 / CC 222 | S22     |                |                |
| CH 32 / CH 232 | E32, R32            | CH 62 / CH 262 | E62, R62 | CC 23 / CC 223 | S23     |                |                |
| CH 33 / CH 233 | E33, R33            | CH 63 / CH 263 | E63, R63 | CC 24 / CC 224 | S24     |                |                |
| CH 34 / CH 234 | E34, R34            | CH 64 / CH 264 | E64, R64 | CC 25 / CC 225 | S25     |                |                |
| CH 35 / CH 235 | E35, R35            | CH 65 / CH 265 | E65, R65 | CC 26 / CC 226 | S26     |                |                |
| CH 36 / CH 236 | E36, R36            | CH 66 / CH 266 | E66, R66 | CC 27 / CC 227 | S27     |                |                |
| CH 37 / CH 237 | E37, R37            | CH 67 / CH 267 | E67, R67 | CC 28 / CC 228 | S28     |                |                |
| CH 38 / CH 238 | E38, R38            | CH 68 / CH 268 | E68, R68 | CC 29 / CC 229 | S29     |                |                |
| CH 39 / CH 239 | E39, R39            | CH 69 / CH 269 | E69, R69 | CC 30 / CC 230 | S30     |                |                |

| CH     | Channel | CH     | Channel | CC     | Frequency (MHz) | CC     | Frequency (MHz) |
|--------|---------|--------|---------|--------|-----------------|--------|-----------------|
| CH 102 | F2      | CH 141 | F41     | CC 110 | 116 - 124       | CC 152 | 391 - 399       |
| CH 103 | F3      | CH 142 | F42     | CC 111 | 124 - 132       | CC 153 | 399 - 407       |
| CH 104 | F4      | CH 143 | F43     | CC 112 | 132 - 140       | CC 154 | 407 - 415       |
| CH 105 | F5      | CH 144 | F44     | CC 113 | 140 - 148       | CC 155 | 415 - 423       |
| CH 106 | F6      | CH 145 | F45     | CC 114 | 148 - 156       | CC 156 | 423 - 431       |
| CH 107 | F7      | CH 146 | F46     | CC 115 | 156 - 164       | CC 157 | 431 - 439       |
| CH 108 | F8      | CH 147 | F47     | CC 116 | 164 - 172       | CC 158 | 439 - 447       |
| CH 109 | F9      | CH 148 | F48     | CC 123 | 220 - 228       | CC 159 | 447 - 455       |
| CH 110 | F10     | CH 149 | F49     | CC 124 | 228 - 236       | CC 160 | 455 - 463       |
| CH 121 | F21     | CH 150 | F50     | CC 125 | 236 - 244       | CC 161 | 463 - 469       |
| CH 122 | F22     | CH 151 | F51     | CC 126 | 244 - 252       |        |                 |
| CH 123 | F23     | CH 152 | F52     | CC 127 | 252 - 260       |        |                 |
| CH 124 | F24     | CH 153 | F53     | CC 128 | 260 - 268       |        |                 |
| CH 125 | F25     | CH 154 | F54     | CC 129 | 268 - 276       |        |                 |
| CH 126 | F26     | CH 155 | F55     | CC 130 | 276 - 284       |        |                 |
| CH 127 | F27     | CH 156 | F56     | CC 131 | 284 - 292       |        |                 |
| CH 128 | F28     | CH 157 | F57     | CC 132 | 292 - 300       |        |                 |
| CH 129 | F29     | CH 158 | F58     | CC 133 | 300 - 306       |        |                 |
| CH 130 | F30     | CH 159 | F59     | CC 141 | 306 - 311       |        |                 |
| CH 131 | F31     | CH 160 | F60     | CC 142 | 311 - 319       |        |                 |
| CH 132 | F32     | CH 161 | F61     | CC 143 | 319 - 327       |        |                 |
| CH 133 | F33     | CH 162 | F62     | CC 144 | 327 - 335       |        |                 |
| CH 134 | F34     | CH 163 | F63     | CC 145 | 335 - 343       |        |                 |
| CH 135 | F35     | CH 164 | F64     | CC 146 | 343 - 351       |        |                 |
| CH 136 | F36     | CH 165 | F65     | CC 147 | 351 - 359       |        |                 |
| CH 137 | F37     | CH 166 | F66     | CC 148 | 359 - 367       |        |                 |
| CH 138 | F38     | CH 167 | F67     | CC 149 | 367 - 375       |        |                 |
| CH 139 | F39     | CH 168 | F68     | CC 150 | 375 - 383       |        |                 |
| CH 140 | F40     | CH 169 | F69     | CC 151 | 383 - 391       |        |                 |

- 
- When two CH/CC numbers correspond to one Channel number, choose either one according to the current COUNTRY setting. When the COUNTRY setting is other than FRANCE, choose a two-digit CH/CC number. When the COUNTRY setting is FRANCE, choose a three-digit CH/CC number.
  - Find the CH/CC number (CC110 to CC161) corresponding to the TV channel (SECAM-L system) from a French cable TV station, based on the broadcast frequency of the TV channel. When you do not know the broadcast frequency, please contact the cable TV station.
  - The CH/CC numbers of CH102-CH169 and CC110-CC161 correspond to the TV channels being broadcast by a SECAM-L system. The other CH/CC numbers correspond to the TV channels being broadcast by a method other than a SECAM-L system.
-

# Troubleshooting

---

If a problem arises while you are using the TV, please read this troubleshooting guide carefully before you ask to have the TV repaired. You may be able to fix it easily by yourself. For example, if the mains plug is disconnected from the mains outlet, or the TV aerial has problems, you may think there is a problem with the TV itself.

## Important:

- This troubleshooting guide only covers problems whose causes are not easy to decide. If you have a question when you are operating a function, read the page(s) for that function carefully, not this troubleshooting guide.
- If you follow the advice in this troubleshooting guide without any success, unplug the mains plug and ask for your TV to be repaired. Do not attempt to repair the TV by yourself or to remove the rear cover of the TV.

## ■ If you cannot turn on the TV

- Is the mains plug connected to the mains outlet?
- Is the power lamp lit? If not, press the  $\odot$  button on the TV.
- Make sure you set the VCR/TV/DVD switch to the TV position. You cannot turn the TV on when the VCR/TV/DVD switch is set to the VCR or DVD position.

## ■ If you cannot turn off the TV

- Make sure you set the VCR/TV/DVD switch to the TV position. You cannot turn the TV off when the VCR/TV/DVD switch is set to the VCR or DVD position.

## ■ No picture or no sound

- Have you chosen a TV channel with very poor reception? If so, the BLUE BACK function will be activated: the entire screen becomes blue, and the sound is muted. If you still want to view the TV channel, follow the description “BLUE BACK” on page 35 to change the BLUE BACK function setting to OFF.
- If the SYSTEM setting for a TV channel is incorrect, it may prevent the sound from being issued. Follow the description “EDIT/MANUAL” on page 37 to use the MANUAL function to try to change the SYSTEM setting.

## ■ Poor picture

- If noise (snow) totally blocks out the picture, there may be a problem with the aerial or aerial cable. Check the following to try to solve the problem:
  - Have the TV and aerial been connected properly?
  - Has the aerial cable been damaged?
  - Is the aerial pointing in the right direction?
  - Is the aerial itself faulty?
- If the TV or aerial suffers interference from other equipment, stripes or noise may appear in the picture. Move any equipment such as an amplifier, personal computer, or a hair drier, that can cause interference away from your TV. Or try moving the TV. If the aerial suffers interference from a radio tower or high-voltage wire, please contact your local dealer.
- If the TV suffers interference from signals reflecting from mountains or buildings, double-pictures (ghosting) will occur. Try to change the aerial’s direction or replace it with one with better directionality.
- Are your COLOUR SYSTEM settings correct? Follow the description “COLOUR SYSTEM” on page 32 to try to solve the trouble.
- Have the COLOUR and BRIGHT settings been adjusted properly? Follow the description “BRIGHT-2” and “COLOUR” on page 29 to try to adjust them properly.

- Videotaping teletext is not recommended because it may not record correctly.
  - When viewing images from commercially available video software products, or videos from videotapes which have been recorded improperly, the top of the image may be distorted. This is due to the condition of the video signal. There is nothing wrong with the TV.
  - Since this TV is designed to make full use of the resolution of the original video source, the motion may appear unnatural when the video source is input with progressive-scanning component signals. If this occurs, change the output setting of the connected device to interlace-scanning component signal output. See the instructions that came with the device for more information.
- **Poor sound**
- Have you adjusted BASS or TREBLE properly? If not, follow the description “BASS” or “TREBLE” on page 33.
  - When TV channel reception is poor, it can be hard to hear stereo or bilingual sound. In this case, follow the description “STEREO / I • II” on page 33 to hear the sound more easily by changing it to a mono sound.
- **If the TV does not respond to the remote control**
- Have the batteries of the remote control worn out? Follow the description “Putting the batteries into the remote control” on page 8 and replace them with new batteries.
  - Have you attempted to use the remote control from the sides or rear of the TV or from more than seven metres away from the TV? Use the remote control in front of your TV or from less than seven metres away.
  - When you are viewing a teletext programme, you cannot operate the menus. Press the **TV** button to return to the ordinary TV programme, and then try operating the menus.
  - If the TV suddenly stops responding, disconnect the power cord of the TV from the AC outlet. Connect them to the AC outlet again to turn on the TV. If the TV returns to a normal state, it is not a failure.
- **Other issues**
- When the SLEEP TIMER function operates, the TV is automatically turned off. If the TV suddenly turns off, try to press the **⏻/I** (standby) button to turn on the TV once again. If the TV goes back to normal, there is no problem.
  - When the TV is receiving a wide-screen signal (WSS) or a signal from an external device affecting the screen size, the ZOOM mode automatically changes. When you want to resume the previous ZOOM mode, press the **ZOOM** button again.
  - It takes a short period of time from the time an operation such as changing channels is performed until an image is displayed. This is not a fault. This is the time needed for the image to stabilize before it can be displayed.
  - The TV may make a crackling sound due to a sudden change in temperature. The picture or sound may be normal. If you hear crackling sounds frequently while you are viewing the TV, there may be other causes. As a precaution, ask your service technician to inspect it.

- The top of the TV and the screen may become hot during use but this has no affect on the performance of the TV. Make sure that the ventilation holes are not blocked.
- When the picture is unstable, the screen may become white for a moment. This happens when the signal which drives the liquid crystal is missing. This is not a fault.
- When a still image has been displayed for a long period, a faint residual image may remain on the screen for a short time after the power has been turned off or when another image is displayed. This is not a fault and the image will eventually disappear.

# Specifications

| Model                    | LT-32C50BU/LT-32C50SU   |
|--------------------------|---|
| Broadcasting systems     | CCIR B/G, I, D/K, L   |
| Colour systems           | PAL, SECAM<br>• The EXT terminals also support the NTSC 3.58/4.43 MHz system.   |
| Channels and frequencies | F2-F10, F21-F69, 116-172, E2-E12, E21-E69, S1-S41, X, Y, Z, Z+1, Z+2, A-H, H+1, H+2, R1-R12, R21-R69<br>• French cable TV channel of broadcast frequencies 116 - 172 MHz and 220 - 469 MHz.   |
| Sound-multiplex systems  | NICAM (B/G, I, D/K, L) system, A2 (B/G, D/K) system   |
| Teletext systems         | FLOF (Fastext), TOP, WST (World Standard System)  |
| Power requirements       | 110 - 240 V AC, 50/60 Hz  |
| Power consumption        | 161 W (Standby: 2.8 W)  |
| Screen size              | Viewable area 80 cm (measured diagonally)   |
| Audio output             | Rated Power output: 10 W + 10 W   |
| Speakers                 | 6.6 cm round × 2  |
| EXT-1 terminal           | Euroconnector (21-pin, SCART)<br>• Video input, S-VIDEO (Y/C) input, Audio L/R inputs and RGB inputs are available.<br>• TV broadcast outputs (Video and Audio L/R) are available.  |
| EXT-2 terminal           | Euroconnector (21-pin, SCART)<br>• Video input, S-VIDEO (Y/C) input, Audio L/R inputs and RGB inputs are available.<br>• Video and Audio L/R outputs are available.<br>• T-V LINK functions are available.  |
| EXT-3 terminal           | RCA connectors × 3<br>S-VIDEO connector × 1<br>• Video input, S-VIDEO (Y/C) input and Audio L/R inputs are available.   |
| EXT-4 terminal           | RCA connectors × 5<br>• Component video (Y, Pb, Pr) input and Audio L/R inputs are available.<br>• 625p, 525p, 1125i and 750p signals are available. 750p signal is only available for 60Hz.<br>• Some DVD players can output 625p, 525p and 750p signals.<br>• 1125i and 750p are new high-definition signals. |
| AUDIO OUT terminal       | RCA connectors × 2<br>• Audio L/R outputs are available.<br>• Output level 0.5 Vrms.  |
| PC INPUT terminal        | Analog RGB D-SUB (15 pin) × 1<br>• PC signal is available. Refer to page 45 for details of the signals which can be input.  |
| Headphone jack           | Stereo mini-jack (3.5 mm in diameter)   |
| Dimensions (W × H × D)   | 834 mm × 568 mm × 108 mm (TV only)  |
| Weight                   | 17.3 kg (TV only)   |
| Accessories              | Remote control unit × 1 (RM-C1811H)<br>AA/R6 dry cell battery × 2   |

## We may change the design and specifications without notice.

Pictures displayed on the screen using this TV's ZOOM functions should not be shown for any commercial or demonstration purpose in public places (cafes, hotels, etc.) without the consent of the owners of copyright of the original picture sources, as this would be an infringement of copyright.



## Specifications

| Model                    | LT-26C50BU/LT-26C50SU   |
|--------------------------|---|
| Broadcasting systems     | CCIR B/G, I, D/K, L   |
| Colour systems           | PAL, SECAM<br>• The EXT terminals also support the NTSC 3.58/4.43 MHz system.   |
| Channels and frequencies | F2-F10, F21-F69, 116-172, E2-E12, E21-E69, S1-S41, X, Y, Z, Z+1, Z+2, A-H, H+1, H+2, R1-R12, R21-R69<br>• French cable TV channel of broadcast frequencies 116 - 172 MHz and 220 - 469 MHz.   |
| Sound-multiplex systems  | NICAM (B/G, I, D/K, L) system, A2 (B/G, D/K) system   |
| Teletext systems         | FLOF (Fastext), TOP, WST (World Standard System)  |
| Power requirements       | 110 - 240 V AC, 50/60 Hz  |
| Power consumption        | 125 W (Standby: 2.8 W)  |
| Screen size              | Viewable area 64.8 cm (measured diagonally)   |
| Audio output             | Rated Power output: 10 W + 10 W   |
| Speakers                 | 6.6 cm round × 2  |
| EXT-1 terminal           | Euroconnector (21-pin, SCART)<br>• Video input, S-VIDEO (Y/C) input, Audio L/R inputs and RGB inputs are available.<br>• TV broadcast outputs (Video and Audio L/R) are available.  |
| EXT-2 terminal           | Euroconnector (21-pin, SCART)<br>• Video input, S-VIDEO (Y/C) input, Audio L/R inputs and RGB inputs are available.<br>• Video and Audio L/R outputs are available.<br>• T-V LINK functions are available.  |
| EXT-3 terminal           | RCA connectors × 3<br>S-VIDEO connector × 1<br>• Video input, S-VIDEO (Y/C) input and Audio L/R inputs are available.   |
| EXT-4 terminal           | RCA connectors × 5<br>• Component video (Y, Pb, Pr) input and Audio L/R inputs are available.<br>• 625p, 525p, 1125i and 750p signals are available. 750p signal is only available for 60Hz.<br>• Some DVD players can output 625p, 525p and 750p signals.<br>• 1125i and 750p are new high-definition signals. |
| AUDIO OUT terminal       | RCA connectors × 2<br>• Audio L/R outputs are available.<br>• Output level 0.5 Vrms.  |
| PC INPUT terminal        | Analog RGB D-SUB (15 pin) × 1<br>• PC signal is available. Refer to page 45 for details of the signals which can be input.  |
| Headphone jack           | Stereo mini-jack (3.5 mm in diameter)   |
| Dimensions (W × H × D)   | 703 mm × 491 mm × 107 mm (TV only)  |
| Weight                   | 13.0 kg (TV only)   |
| Accessories              | Remote control unit × 1 (RM-C1811H)<br>AA/R6 dry cell battery × 2   |

### We may change the design and specifications without notice.

Pictures displayed on the screen using this TV's ZOOM functions should not be shown for any commercial or demonstration purpose in public places (cafes, hotels, etc.) without the consent of the owners of copyright of the original picture sources, as this would be an infringement of copyright.

# JVC



**JVC**